



## **BYD COMMERCIAL STORAGE SOLUTION**

### **BATTERY-MAX LITE**

**Copyright © Shenzhen BYD Electronics Co., Ltd. 2024. All rights reserved.**

No part of this document could be reproduced or transmitted in any form or by any way without prior written consent of Shenzhen BYD Electronics Co., Ltd.

## **Trademarks and Permissions**



and other BYD trademarks used in this manual are the property of Shenzhen BYD Electronics Co., Ltd. All other trademarks and trade names mentioned in this document are the property of their respective owners. All trademarks are recognized.

## **Legal Provisions**

Shenzhen BYD Electronics Co., Ltd. makes no representations or warranties express or implied, with respect to this document or any of the equipment and/or software it may describe, including (with no limitation) any implied warranties of utility, merchantability, or fitness for any particular purpose. All such representations or warranties are expressly disclaimed. Neither Shenzhen BYD Electronics Co., Ltd. nor its distributors or dealers shall be liable for any indirect, incidental, or consequential damages under any circumstances.

The exclusion of implied warranties may not apply in all cases under some statutes, and thus the above exclusion may not apply.

This document does not replace and is not intended to replace any local, state, provincial, federal, or national laws, regulations, or codes applicable to the installation and use of the battery system as well as electrical safety. Shenzhen BYD Electronics Co., Ltd. assumes no responsibility for the compliance or noncompliance with such laws or codes in connection with the installation of the battery system.

Specifications and other information in this document are subject to change without notice. Every effort has been made to make this document complete, accurate, and up-to-date. However, Shenzhen BYD Electronics Co., Ltd. may need to make some improvements under certain circumstances without advance notice. Shenzhen BYD Electronics Co., Ltd. shall not be responsible for any loss caused by this document, including, but not limited to, omission errors, typographical errors, arithmetical errors, or listing errors in this document.

## **Shenzhen BYD Electronics Co., Ltd.**

Address: No.1, Yan'an Road, Kuichong, Dapeng, Shenzhen, Guangdong Province, 518119, P. R. China.

Website: [www.bydbatterybox.com](http://www.bydbatterybox.com).

# Content

<b>1. Information in this document</b>	<b>7</b>
1.1. Target Group	7
1.2. Symbol Conventions	7
1.3. Symbol on Products	8
1.4. Designation in the Document	9
<b>2. Safety Information</b>	<b>10</b>
2.1. Personal Requirements	10
2.2. Important Safety Instructions	10
2.2.1. Battery Module Leakage	10
2.2.2. Firefighting Measures	10
2.2.3. Battery Modules Handling and Storage Guide	10
2.3. Electrical Safety	11
2.4. Installation and Wiring	12
2.5. Operation and Maintenance	12
2.6. Transporting the Battery	13
<b>3. Product Description</b>	<b>15</b>
3.1. Model Description	15
3.2. Product Introduction	15
3.3. Intended Use	15
3.4. Components	16
3.4.1. Components (exterior)	16
3.4.2. Components (Internal)	17
3.5. Technical Specifications	18
3.6. Safety Equipment	19
3.6.1. Smoke Detector	19
3.6.2. Door Status Sensor	19
3.6.3. Emergency Stop Button	19
3.6.4. Alarm Light	20
3.6.5. LED Status	20

3.7. Interface.....	20
<b>4. Scope of Delivery.....</b>	<b>21</b>
4.1. Battery Module Package.....	21
4.2. Cabinet Package.....	22
<b>5. Installation.....</b>	<b>23</b>
5.1. Requirements for Installation Environment.....	23
5.1.1. Requirements for Installation Location.....	23
5.1.2. Requirements for Foundation.....	23
5.1.3. Requirements for Installation Space.....	25
5.1.4. Requirements for Top Space.....	26
5.2. Unpacking and Acceptance.....	26
5.3. Forklift Transport.....	26
5.4. Hoisting and Transport.....	27
5.4.1. Safety Precautions.....	27
5.4.2. Hoisting.....	28
5.5. Tools.....	28
5.6. Safety Gear.....	29
5.7. Additionally Required Installation Materials (Not Included In the Scope of Delivery).....	29
5.8. Fixed Installation.....	29
5.8.1. Drilling the Holes.....	30
5.8.2. Installing the Expansion Screws.....	30
5.9. Adjust the Direction of the Alarm Light.....	30
5.10. Open the Door.....	31
5.11. Remove the Deflector Panel.....	31
5.12. Installing the Battery Modules.....	31
5.12.1. Notes for Unpacking and Handling the Battery Module.....	31
5.12.2. Measure the Voltage of All the Battery Modules.....	32
5.12.3. Install the Battery Module.....	32
5.13. Adjust the Position of the Positive Power Cable Junction Kit.....	33
<b>6. Electrical Connection.....</b>	<b>34</b>

6.1. Precautions.....	34
6.2. Preparation before Wiring.....	35
6.2.1. Procedure for Assembling the External Cable Glands.....	35
6.3. Connecting a Ground Cable for the Cabinet.....	37
6.4. Battery Module and PDU Wiring.....	38
6.4.1. Battery Module Connection Interface Instruction.....	38
6.4.2. PDU Connection Interface Instruction.....	39
6.4.3. Connect the BIC Communication Cable.....	40
6.4.4. Connect the Fan Cable.....	41
6.4.5. DC Connection for the Battery Modules.....	42
6.4.5.1. Connect the Copper Bar 2 (Positive).....	42
6.4.5.2. Connect the Copper Bar 1 ( Adjacent Battery Modules).....	42
6.4.5.3. Connect the Copper Bar 3 (Negative).....	42
6.4.6. Power Cable Connection.....	43
6.4.7. Communication Cables Connection to an Inverter.....	46
6.4.8. Network Cable Connection to External Router.....	48
6.4.9. Auxiliary AC Power Supply Connection.....	49
6.5. Install the cover.....	50
6.6. Parallel Communication Connection between Cabinet.....	51
<b>7. Commissioning.....</b>	<b>52</b>
7.1. Switch On the Battery System.....	52
7.2. Configuration.....	53
7.3. Switch On and Commission the Inverter.....	55
<b>8. Operation.....</b>	<b>56</b>
8.1. Switch On the Battery System.....	56
8.2. Switch Off the Battery System.....	56
8.3. Black Start Function.....	56
8.4. Wi-Fi.....	56
8.5. Air Conditioning Working Strategy.....	57
8.5.1. Cooling Mode.....	57

8.5.2. Heating Mode.....	57
8.6. Fan Working Strategy.....	57
<b>9. Decommissioning.....</b>	<b>58</b>
<b>10. Extension.....</b>	<b>59</b>
<b>11. Troubleshooting.....</b>	<b>60</b>
<b>12. Maintenance and Storage.....</b>	<b>61</b>
12.1. Cleaning.....	61
12.2. Storage.....	61
12.3. Maintenance.....	62
12.3.1. Precautions Before Maintenance.....	62
12.3.2. Maintenance Item and Period.....	62
12.3.2.1. Maintenance (Every Two Years).....	62
12.3.2.2. Maintenance (Once a Year).....	63
12.3.2.3. Maintenance (Every Six Months to Once a Year).....	64
<b>13. Disposal of the Battery.....</b>	<b>65</b>
<b>14. Contact Information.....</b>	<b>66</b>
<b>Appendix 1 Connection Options with Inverters.....</b>	<b>67</b>
<b>Appendix 2 Checklist.....</b>	<b>70</b>

# 1. Information in this document

This document is the operating manual for the Battery-Max Lite.

This document contains safety information, product description, scope of delivery, installation, electrical connection, commissioning, operation, decommissioning, extension, troubleshooting, maintenance and storage, and disposal of the battery.

Please finish reading this document carefully to understand all the safety information as well as the functions and features of the Battery-Max Lite before taking any actions on the battery system.

## 1.1. Target Group

The instructions in this document may only be performed by qualified persons who must have the following skills:

- Knowledge of how a battery works and be operated
- Knowledge of how an inverter works and can be operated
- Knowledge of, and adherence to the locally applicable connection requirements, standards, and directives
- Knowledge of, and adherence to this document and the associated system documentation, including all safety instructions
- Trained in dealing with the hazards associated with the installation and operation of electrical equipment and battery
- Trained in the installation and commissioning of electrical equipment
- Electrical and electrical equipment installation qualification certificates issued with local legal permission

Failure to do so will void any manufacturer's warranty, guarantee or liability null, and void unless you can prove that the damage was not due to non-compliance.

## 1.2. Symbol Conventions

To ensure the safety of the users and their properties when they use the product and to make sure that the product is used in an optimal and efficient manner, this manual provides users with the relevant safety information highlighted by the following symbols.

Below is a list of symbols that are used in this manual. Review them carefully to make better use of this manual.



Indicates a hazardous situation which, if not avoided, could result in death or serious injury.



Indicates a hazardous situation which, if not avoided, could result in death or serious injury.

 **CAUTION**

Indicates a hazardous situation which, could result in minor or moderate injury.







**NOTICE**

Indicates a situation which, if not avoided, could result in property damage.

 **QUALIFIED PERSON**

Sections describing activities to be performed by qualified persons only.

### 1.3. Symbol on Products

Symbol	Explanation
	<b>Observe the documents</b> Observe all documents supplied with the system
	<b>Grounding conductor</b> This symbol indicates the position for connecting a grounding conductor.
	<b>Disposal</b> Do not dispose of the system together with household waste. Please contact BYD service team (contact information at the end of this document) to dispose of it in accordance with regulations for electronic waste and used batteries.
	<b>CE marking</b> The system complies with the requirements of the applicable EU directives.
	<b>UKCA marking</b> The product complies with the regulations of the applicable laws of England, Wales and Scotland.
	<b>This side up.</b>
	<b>Handle with care.</b>



Keep dry.



Do not press the top.



Keep the battery modules away from open flame or ignition sources.



Beware of electrical shock.



Beware of the danger zone

This symbol indicates that the system must be additionally grounded if additional grounding or equipotential bonding is required at the installation site.



Keep the battery modules away from children.

#### 1.4. Designation in the Document

Designation in this document	Complete designation
Battery system	Battery-Max Lite
BIC	Battery Information Collector
BYD	Shenzhen BYD Electronics Co., Ltd.
MCU	Micro Control Unit
PDU	Power Distribute Unit
SOC	State of Charge

## 2. Safety Information

### 2.1. Personal Requirements

The hoisting, transportation, installation, wiring, operation, and maintenance of the battery system must be carried out by professional electrical technicians in accordance with local regulations. The professional technician is required to meet the following requirements:

- Should know electronic, electrical wiring and mechanical expertise, and be familiar with electrical and mechanical schematics.
- Should be familiar with the composition and working principles of the battery system and its front- and rear-level equipment.
- Should have received professional training related to the installation and commissioning of electrical equipment.
- Be able to quickly respond to hazards and emergencies that occur during installation and commissioning.
- Be familiar with the relevant standards and specifications of the country/region where the project is located.

### 2.2. Important Safety Instructions

The battery system has been designed and tested in accordance with international safety requirements. However, in order to prevent personal injury and property damage and ensure the long-term operation of the battery system, please do read this section carefully and observe all safety information at all times.

#### 2.2.1. Battery Module Leakage

If the battery modules leak electrolytes, avoid contact with the leaked liquid or gas. The electrolyte is corrosive, and the contact may cause skin irritation and chemical burns. If someone is exposed to the leaked substance, please do these actions:

**Inhalation**      Evacuate the contaminated area, and seek medical help immediately.

**Eye contact**      Rinse eyes with flowing water for 15 minutes and seek medical help immediately.

**Skin contact**      Wash the affected area thoroughly with soap and water and seek medical help immediately.

**Ingestion**      Induce vomiting and seek medical help immediately.

#### 2.2.2. Firefighting Measures

The battery system may catch fire if placed in the fire. In case of a fire, please make sure that an ABC or carbon dioxide extinguisher is nearby. Water cannot be used to extinguish the fire.

Full protective clothing and self-contained breathing apparatus are required for the firefighters to extinguish the fire.

#### 2.2.3. Battery Modules Handling and Storage Guide

- The battery modules and its components should be protected from damage when transporting and handling.

- Do not impact, pull, drag, or step on the battery modules.
- Do not insert unrelated objects into any part of the battery modules.
- Do not throw the battery module into a fire.
- Do not soak the battery modules in water or seawater.
- Do not expose to strong oxidizers.
- Do not short circuit the battery modules.
- The battery modules cannot be stored at high temperatures (more than 55°C).
- The battery modules cannot be stored directly under the sun.
- The battery modules cannot be stored in a high humidity environment.
- Do not use the battery modules if it is defective, or appears cracked, broken or otherwise damaged, or fails to operate.
- Do not attempt to open, disassemble, repair, tamper with, or modify the battery modules. The battery modules are not user-serviceable.
- Do not use cleaning solvents to clean the battery modules.

### 2.3. Electrical Safety

#### DANGER

##### **Danger to life due to electric shock when live components or DC cables are touched**

The DC cables connected to an inverter may be live. Touching live DC cables results in death or serious injury due to electric shock.

- Disconnect the battery system and inverter from voltage sources and make sure it cannot be reconnected before working on the device.
- Do not touch non-insulated parts or cables.
- Do not remove the terminal block with the connected DC conductors from the slot under load.
- Wear suitable personal protective equipment for all work on the battery system.
- Observe all safety information of the inverter manufacturer.

#### DANGER

##### **Danger to life due to electric shock in case of overvoltage and if surge protection is missing**

Overvoltage (e. g., in the event of a flash of lightning) can be further conducted into the building and to other connected devices in the same network via the network cables or other data cables if there is no surge protection. Touching live parts and cables results in death or lethal injuries due to electric shock.

When laying the network cables or other data cables outdoors, it must be ensured that a suitable surge protection device is provided at the transition point of the cable from the battery system or the inverter outdoors to the inside of a building.

 **CAUTION**

**Risk of injury due to weight of the battery Module**

Injuries may result if the battery stack is lifted incorrectly or dropped while being transported or installed.

- Transport and lift the battery stack carefully. Take the weight of the battery stack into account.
- Wear suitable personal protective equipment for all work on the battery system.

**NOTICE**

**Damage to the electrical equipment in the cabinet, or impair their functionality due to sand, dust and moisture ingress.**

- Only open the cabinet if the humidity is within the thresholds and the environment is free of sand and dust.
- Perform electrical connection when there is no sandstorm and the weather is fair and dry.

**NOTICE**

**Damage to the battery system due to undervoltage**

- If the battery system doesn't start at all, please contact BYD local after-sales service within 48 hours. Otherwise, the battery could be permanently damaged.

## 2.4. Installation and Wiring

 **WARNING**

In the whole process of mechanical installation, the relevant standards and requirements of the project location must be strictly observed.

 **WARNING**

Only equipment designated by BYD can be used. Failure to use equipment designated by BYD may cause damage to the protection function and injury to personnel.

## 2.5. Operation and Maintenance

 **DANGER**

Dismantling or burning the battery may cause it to catch fire.

 **WARNING**

Personal protective equipment is required for maintenance and service of the battery system. Maintenance personnel must wear protective equipment such goggles, helmets, insulated shoes, gloves, etc.

 **WARNING**

There are no user-maintainable parts inside the battery module.

Only personnel approved by BYD can remove, replace and dispose of the batteries. Users are not allowed to maintain batteries without guidance.

 **WARNING**

To ensure continuous fire protection, replacement of internal components should only be performed by professional personnel.

**NOTICE**

Do not spray paint any internal or external component of the product.

Do not use cleaning agents to clean the product or expose it to harsh chemicals.

## 2.6. Transporting the Battery

 **QUALIFIED PERSON**

This section contains safety information that must be observed at all times when transporting the battery.

 **WARNING**

### **Risk of injury due to the weight of the battery modules**

Injuries may occur if the battery modules are lifted incorrectly or dropped while being transported or installed.

- Transport and lift the battery modules carefully. Take the weight of each individual module into account.
- Transport battery modules individually only.
- Wear suitable personal protective equipment, at a minimum safety footwear with a non-slip sole and steel cap, for all work on the battery.

 **CAUTION**

### **Risk of injury due to inappropriate transport of the battery cabinet**

Inappropriate transport or insufficient transport securing devices can cause the battery cabinet to slip or tip over.

The battery cabinet can cause injuries if it slips or tips over during transport.

- Transport and lift the battery cabinet carefully. Take the weight of the battery cabinet into account.
- Wear suitable personal protective equipment, at a minimum safety footwear with a non-slip sole and steel cap, for all work on the battery.
- Position the battery cabinet upright in the vehicle and prevent it from slipping.
- Secure the battery cabinet against slipping and tipping over with restraining straps.

## NOTICE

### Damage to the battery due to transporting the battery cabinet with battery modules installed

Transporting the battery cabinet with battery modules installed can cause mechanical overload. Mechanical overload can damage the battery.

- Always transport the battery cabinet and battery modules separately.
- Never move the battery cabinet with battery modules installed.

The battery module weigh up to 75 kg and therefore are not suitable for transport by one person.

- Use suitable means of transport, e.g., forklift. Do not damage the enclosure of the battery components.
- When handle or lift the battery module, apply force to the handle as shown in the figure below.

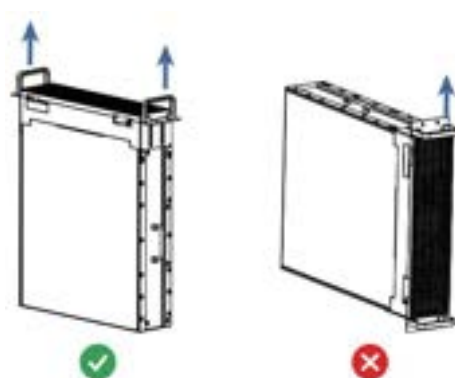

All requirements of the Dangerous Goods Ordinance on Road, Rail, and Inland Navigation and the Convention on the International Carriage of Dangerous Goods by Road must always be complied with:

- Only trained and instructed personnel are allowed to transport the battery modules on public roads. The instruction must be documented and repeated.
- Smoking is not permitted in the vehicle during the journey.
- Smoking is not permitted in the vehicle itself or in the immediate vicinity during loading and unloading.
- Two tested fire class D metal fire extinguishers (minimum capacity 2 kg) and one set of hazardous goods equipment in accordance with the Convention on the International Carriage of Dangerous Goods by Road must be carried in the vehicle.
- The outer packaging of the battery module must not be opened during transport.

## 3. Product Description

### 3.1. Model Description

This document involves the product model: Battery-Max Lite 30, 37.5, 45, 52.5, 60, 67.5, 75, 82.5, 90.

### 3.2. Product Introduction

It is a high-voltage Li-ion battery storage system, with the control module on itself. It could be operated in on-grid, off-grid and backup modes with compatible inverters.

One Battery-Max Lite provides capacities of 30 to 90 kWh. Connecting up to 32 Battery-Max Lite in parallel allows system capacities up to 2.88 MWh. The standardized outdoor design, allows for easy and flexible positioning with optional hangers on the side of the inverter.

**Note: Four to twelve** battery modules could be installed in one cabinet and the quantity of the battery modules per cabinet should be equal when multi cabinets are parallel installed.

### 3.3. Intended Use

The battery system is for commercial and industrial (C&I) use and works with a photovoltaic system.

The battery system could be connected to the internet through a network cable for maintenance and firmware updating.

The battery system must only be used as stationary equipment.

The battery system is suitable for indoor and outdoor use under the conditions mentioned in Section 4.

The battery system must only be operated in connection with a compatible inverter. The list (Battery-Max Lite Compatible Inverter List) of these inverters can be found at [www.bydbatterybox.com](http://www.bydbatterybox.com) or [www.bydenergy.com](http://www.bydenergy.com).

The battery system is not suitable for supplying life-sustaining medical devices. Please ensure that no personal injury would occur due to the power outage of the battery system.

Alterations to the battery system, e.g., changes or modifications are not allowed unless the written permission of BYD is achieved. Unauthorized alterations will void the guarantee and warranty claims. BYD shall not be held liable for any damage caused by such changes.

The type label should always be attached to the battery system.

The nameplate contains important parameter information related to the battery system, and shall be protected during transportation, installation, maintenance and troubleshooting. It is strictly prohibited to damage or dismantle the nameplate.

### 3.4. Components

#### 3.4.1. Components (exterior)

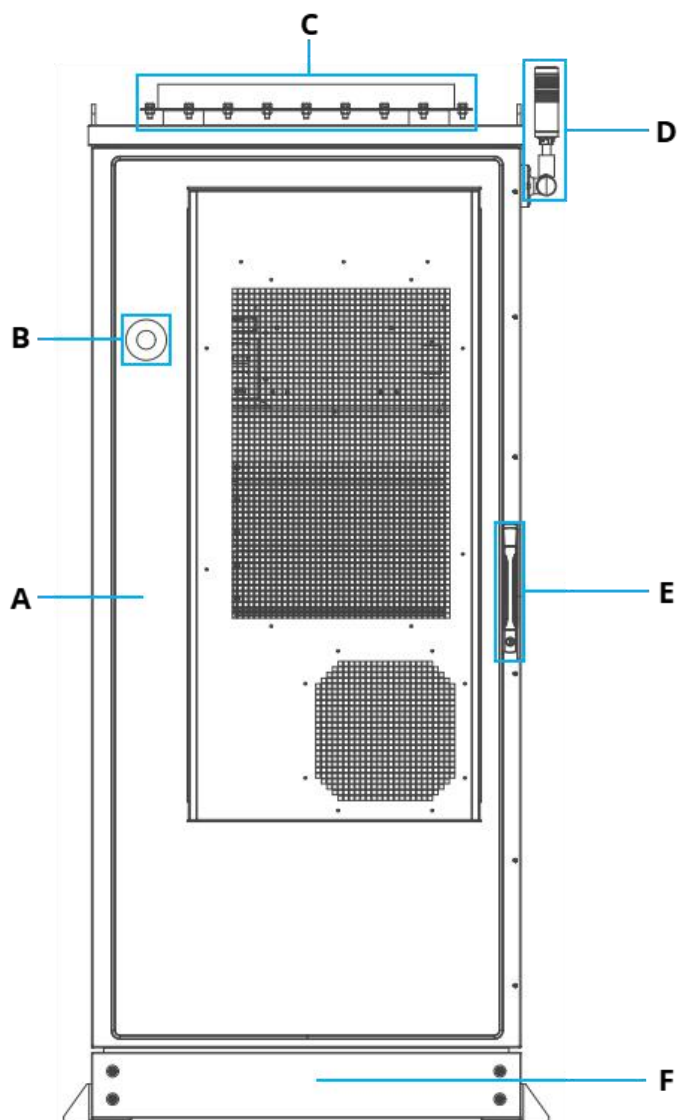

No.	Name	No.	Name
A	Door	D	Alarm light
B	Emergency stop button	E	Door lock
C	Pressure relief window	F	Cover

### 3.4.2. Components (Internal)

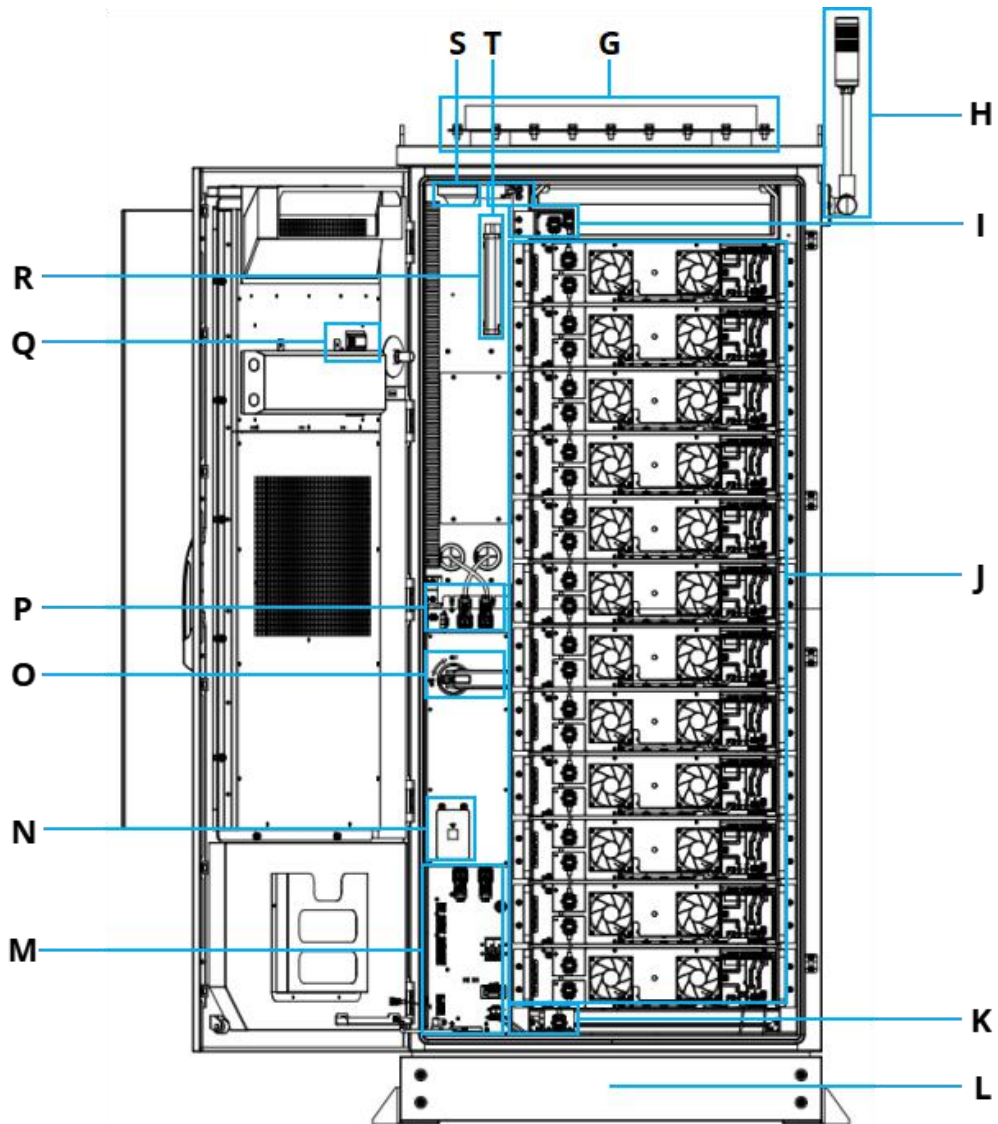

No.	Name	No.	Name
G	pressure relief window	N	Wi-Fi module
H	Alarm light	O	PDU handle switch
I	Positive junction kit	P	B+/ B- cable
J	Battery module	Q	Air conditioner control panel
K	Negative junction kit	R	Light
L	Cover	S	Smoke detector
M	PDU interface panel	T	Door status sensor

### 3.5. Technical Specifications

#### PERFORMANCE

Battery Module	LITE Module (7.5 kWh, 76.8 V, 75 kg)								
Number of Modules	4	5	6	7	8	9	10	11	12
Usable Energy <sup>[1]</sup>	30 kWh	37.5 kWh	45 kWh	52.5 kWh	60 kWh	67.5 kWh	75 kWh	82.5 kWh	90 kWh
Nominal Voltage	307 V	383 V	460 V	537 V	614 V	691 V	767 V	844 V	921 V
Operating Voltage	259~355 V	324~444 V	389~532 V	453~621 V	518~710 V	583~799 V	648~888 V	712~976 V	777~1065 V
Weight	700 kg	775 kg	850 kg	925 kg	1000 kg	1075 kg	1150 kg	1225 kg	1300 kg

#### GENERAL DATA

Dimensions (H/W/D)	2205 x 920 x 1300 mm
Rated capacity	100 Ah
Max. Charge Current <sup>[2]</sup>	100 A
Max. Discharge Current <sup>[2]</sup>	100 A
Peak Output Current <sup>[2]</sup>	170 A, 3 s
Operating Temperature	-20 °C to +50 °C
Battery Cell Technology	Lithium Iron Phosphate (cobalt-free)
Communication	CAN / RS485 / Modbus TCP
Enclosure Protection Rating	IP55
Battery Module IP class	IP20
Round-trip Efficiency	≥ 95%
Certification	CE / UN38.3 / IEC62040 / IEC62619
Applications	ON Grid / ON Grid + Backup / OFF Grid / Black Start / Start from AC / Pre-charge Circuit
Warranty <sup>[3]</sup>	Max 10 Years
Compatibilities	Please refer to BYD Battery-Max Lite Compatibility List
Battery Design	IFpP/51/161/119/[24S]M/-20+50/90

[1] DC Usable Energy, Test conditions: 100% DOD, 0.2 C charge & discharge at + 25 °C. System usable energy may vary due to system configuration parameters.

[2] Power derating will occur between -20 °C and +5 °C.

[3] Conditions apply. Refer to BYD Battery-Max Lite Limited Warranty Letter.

### 3.6. Safety Equipment

#### 3.6.1. Smoke Detector

When the smoke detector detects smoke, it transmits a signal to the control system, which will disconnects the positive and negative relays of the whole the battery cabinets.

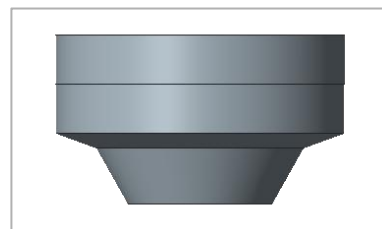

#### 3.6.2. Door Status Sensor

When the door status sensor detects that the door is in the closed status, the light will be off;

When the door status sensor detects that the door is in the open status, the light will be on and all the positive and negative relays of the all the battery cabinets will be off.

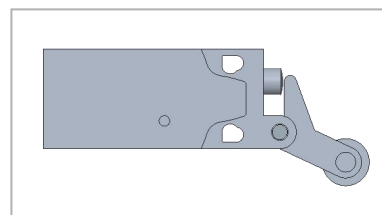

#### 3.6.3. Emergency Stop Button

In case of emergency, press this button to stop the system.



Pressing the emergency stop button only disconnects the positive and negative relays., the internal auxiliary power supply and PCB board remain energized and should not be touched!

After pressing the emergency stop button, the emergency stop signal will be sent to the positive relay driver and directly disconnect the positive relay.

At the same time, the emergency stop signal will be sent to the MCU, and the MCU will respond according to the received emergency stop signal, such as disconnecting the positive and negative relays, recording the action information of the emergency stop button, etc.

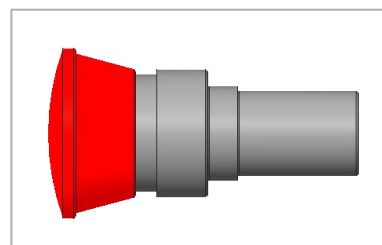

#### Circuit diagram:

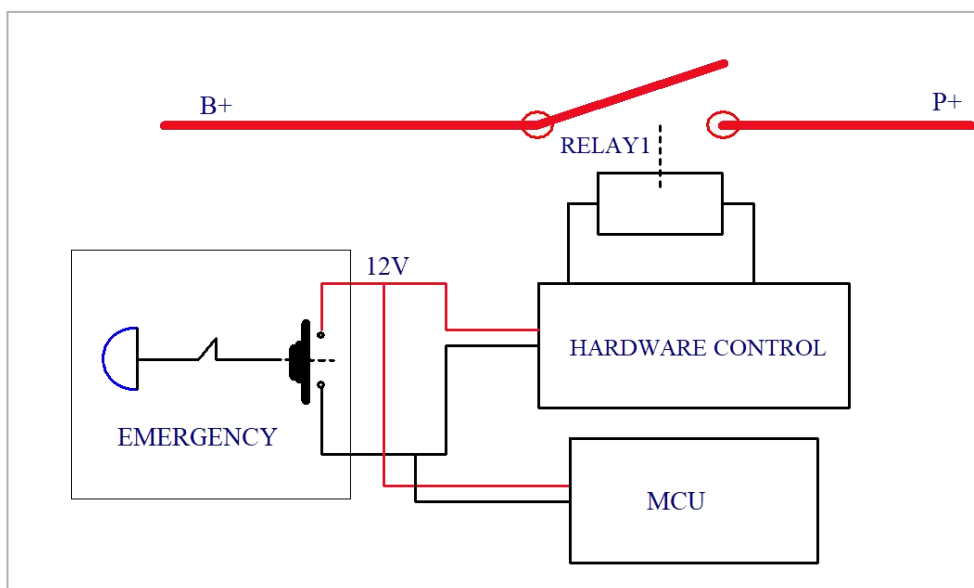

### 3.6.4. Alarm Light

Normal operation status:	Green light is always on, red light is always off.
Alarm operation status:	Green light flashes once with a period of 1 second, red light is always off.
Fault shutdown status:	Green light is always off, red light is always on.
Shutdown failure status:	Green light and red light are always on.

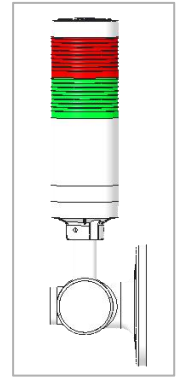

### 3.6.5. LED Status

Normal status	LED blinks for a long time with a cycle of 1 second.
Shutdown status	LED always is off.
Black start	LED blinks on and off for 5 cycles with a cycle of 0.4s (on for 0.2s and off for 0.2s is one cycle).
Wi-Fi reset	LED blinks on and off for 5 cycles with a cycle of 0.4s (on for 0.2s and off for 0.2s is one cycle).
Shutdown failure feedback	LED always is on.

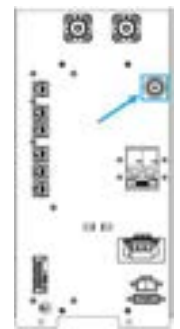

## 3.7. Interface

### BYD Max Lite

BYD Max Lite is an app for Android and iOS system devices which can be downloaded from Google Play or App Store.

With BYD Max Lite, you can update the firmware, configure the battery system, read the battery status and events, download logs, etc.

### BYD Max Lite Plus

BYD Max Lite Plus is a PC application which can be downloaded from our website: [www.bydbatterybox.com](http://www.bydbatterybox.com) or [www.bydenery.com](http://www.bydenery.com).

With BYD Max Lite Plus, you can configure and diagnose the battery system, read the general battery status information and events, update the firmware, download historical events, etc.

### Be Connect Monitoring

The battery system is equipped with an "ETH" port as a standard. When your battery system accesses the internet, it will join the Be Connect Monitoring, which is a platform that BYD service team could diagnose the battery system and update firmware remotely for customers. It is highly recommended you make the internet connection available to have a better service.

## 4. Scope of Delivery

### 4.1. Battery Module Package



Position	Quantity	Designation
A	1	Battery module
B	5	M6*16 screw for fixing the battery module(s)
C	1	Fan cable 1 (between battery modules)
D	1	BIC communication cable
E	1	Copper bar 1 (adjacent battery modules)

## 4.2. Cabinet Package



F



G



H



I



J



K



L



M



N



O



P



Q



S



T



U

Position	Quantity	Designation
F	1	Cabinet
G	2	Key of the cabinet door
H	1	Copper bar 2 (positive )
I	1	Copper bar 3 (negative)
J	1	Positive power connector
K	1	Negative power connector
L	1	Plug and pull terminal
M	1	Fan cable loop terminal
N	1	BIC loop terminal
O	1	SPI cable
P	1	Fan cable 2 (PDU to module)
Q	8	Expansion screw M12*70
S	2	Cover
T	8	M6*35 for fixing the cover
U	1	Air conditioning drain pipe

## 5. Installation

### 5.1. Requirements for Installation Environment

#### 5.1.1. Requirements for Installation Location

- a) The climate environment and geological conditions, such as underground water level, should be fully considered when selecting the installation site.
- b) The environment around the installation site should be dry and well ventilated.
- c) There should be no trees around the installation site to prevent branches or leaves blown off by heavy winds from blocking the door or air inlet of the cabinet.
- d) The installation site should be away from areas where toxic and harmful gases are concentrated, and free from inflammable, explosive and corrosive materials.
- e) The installation site must be at least 2000 m away from the seaside.
- f) The installation location must be inaccessible to children.
- g) The installation location must be suitable for the weight and dimensions of the battery system.
- h) The installation location must not be exposed to direct solar irradiation, rainwater and snow.
- i) The horizontal level of the installation site shall be above the highest water level of that area in history. The site must not be located in a low-lying land.
- j) The installation location must not be close to the fire.
- k) The altitude of the installation location should be less than 3000 m.
- l) The ambient temperature should be between -20 °C and +50 °C.
- m) The ambient humidity should be between 5% and 75% (non-condensing).

#### 5.1.2. Requirements for Foundation

 **WARNING**

The battery system is heavy. Before constructing the foundation, it is necessary to inspect the installation site in detail (mainly referring to the geological conditions and environmental climatic conditions, etc.). commence the design and construction of the foundation only after confirming that all requirements are met.

Unreasonably constructed foundation will bring great troubles to the installation of the battery system, affecting the normal opening and closing of the doors and the normal operation. Therefore, the foundation of the battery system must be designed and constructed according to certain standards to meet the requirements of mechanical support, cable routing and later maintenance and overhaul.

The cabinet weighs 1.3 tons when fully loaded. A solid support surface must be available. At least the following requirements shall be met during foundation construction:

- a) The soil at the installation site should be compact.

- b) Compact and fill the foundation pit to provide sufficient and effective support for the cabinet.
- c) Raise the foundation to prevent the cabinet base and the interior from rain erosion.
- d) The cross-sectional area and height of the foundation should meet the requirements.
- e) Construct corresponding drainage in conjunction with local geological conditions.
- f) Built a cement foundation with sufficient cross-sectional area and height. The foundation height is determined by the construction party according to the site geology.
- g) Consider cable routing when building the foundation.
- h) The installation location must not be close to the water. If there are special installation requirements (such as in areas prone to water ingress), the cabinet must always be installed in an elevated position that cannot be reached by flooding.

#### **NOTICE**

The dregs excavated during foundation construction should be removed immediately to avoid latter impact on lifting.

- i) During the foundation construction, reserve enough space for the AC/DC side cable trench according to the position and size of the cable inlet and outlet holes of the battery system, and pre-embed the cable conduit.
- j) A drainage system is necessary to prevent the bottom or internal equipment of the battery system from being soaked in water during the rainy season or during heavy rainfall.
- k) Both ends of all embedded pipes should be temporarily sealed to prevent impurities from entering and causing troubles to later wiring.

### 5.1.3. Requirements for Installation Space

To ensure that the cabinet door can be opened normally and the cabinet is easy to be dissipated heat and maintained, sufficient space needs to be reserved around the installation site. At least 650 mm of space needs to be reserved on the left and right sides of the cabinet, and 1300 mm of space needs to be reserved in front of the cabinet door.

The space of the back of the product is not required, so the products can be installed "back to back" to save installation space.

The top view of installation space could be read below:

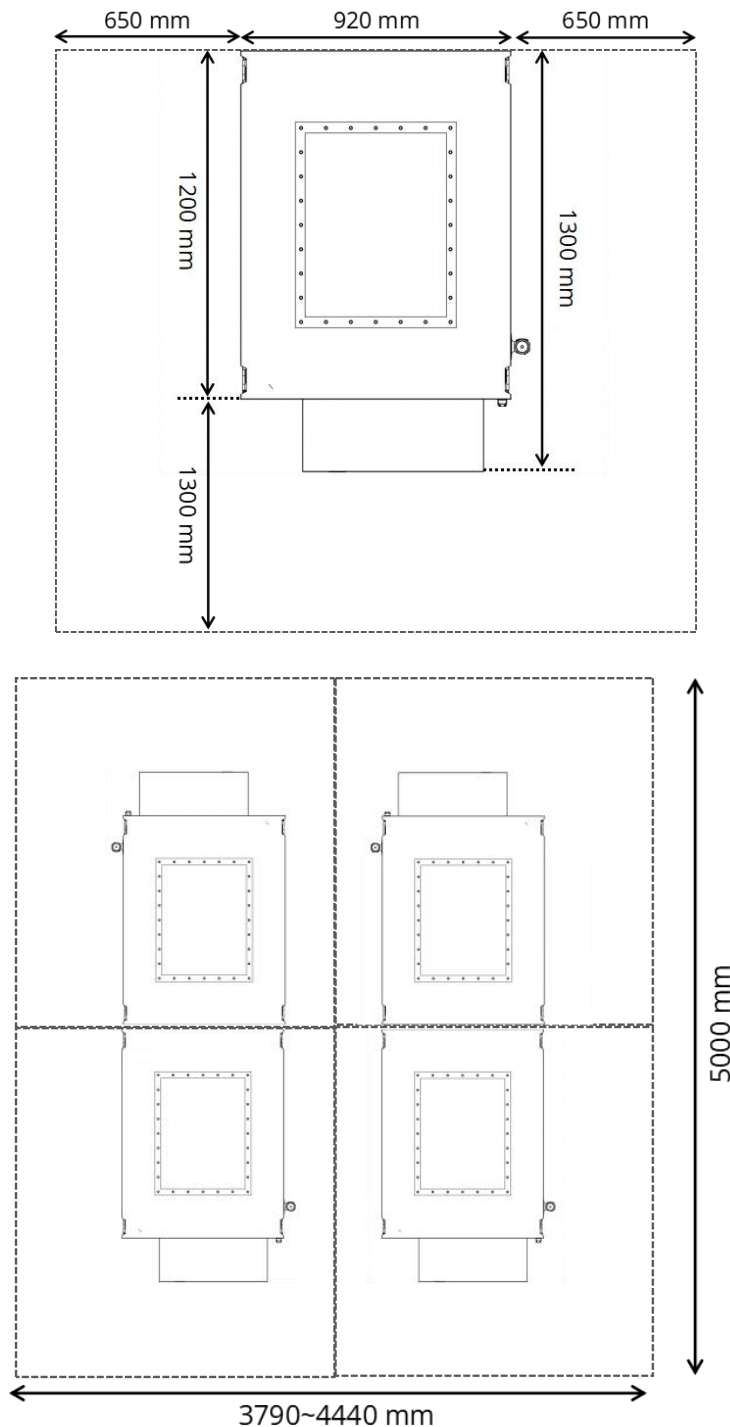

#### 5.1.4. Requirements for Top Space

There is a pressure relief window on the top of the cabinet, one side of which is fixed and the other three sides are movable.

When the pressure difference between the inside and outside of the cabinet reaches the 0.1 barg standard, the pressure relief window will be opened around the fixed part and release the contents vertically to reduce systemic safety risks. Therefore, **at least 500 mm** of barrier-free space is reserved above the cabinet to ensure that the pressure relief window can open normally.

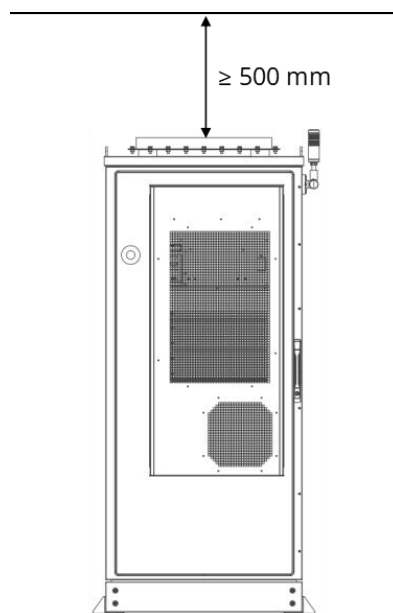

#### 5.2. Unpacking and Acceptance

To prevent the equipment from falling over, secure it to a forklift using ropes before moving it. Move the equipment with caution to avoid bumping or falling, which may damage the equipment.

After placing the equipment in the installation position, unpack it with care to prevent scratches. Keep the equipment stable during unpacking.

After unpacking, check whether the fastening components and removable components are loose. If they are loose, notify the carrier and manufacturer immediately.

Before unpacking batteries, check whether the packaging is intact. Do not use batteries with damaged packaging. If any damage is found, notify the carrier and manufacturer immediately.

If the installation environment is poor, take dust proof and anti-condensation measures (for example, use a dust cover, plastic film, or fabric cloth) after unpacking batteries to prevent condensation and dust buildup, which may corrode the batteries.

#### 5.3. Forklift Transport

If the installation site is flat, you can use a forklift to move the cabinet. The bottom of the cabinet equipped with fork site specially used for forklift transportation.

If a forklift is used, the following requirements should be met:

- The forklift should be equipped with sufficient load capacity.

- The length of the forklift feet should meet the requirements of the device.

The forklift feet should be inserted into the fork pockets at the bottom of the cabinet.

- The transportation, moving and putting down of the battery module and cabinet should be slow and stable. It is recommended to try transportation.
- Only place the cabinet in a stable place. The place should be well drained without any obstruction or bulging. The cabinet should be fixed by four bottom corner pieces.

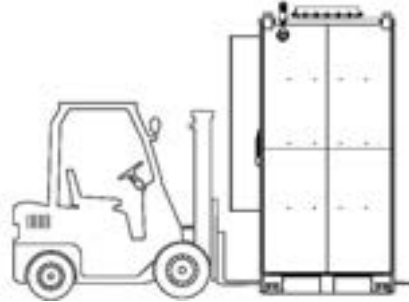

## 5.4. Hoisting and Transport

### 5.4.1. Safety Precautions

When lifting the device, at least the following requirements must be met:

- All safety requirements must be met.
- A professional instructor is needed in the whole hoisting process.
- The strength of the sling used should be able to withstand the weight of the devices.
- Ensure that all sling connections are safe and reliable, and that the lengths of the slings connected to the corner fittings are equal.
- The length of the sling can be adjusted appropriately according to the actual requirements of the site.
- During the lifting process, the devices must be stable and not skewed.
- Please lift the cabinet from the top.
- Take all necessary auxiliary measures to ensure the safe and smooth lifting of the devices.

The cabinet connection points of the lifting device can be see below:



## 5.4.2. Hoisting

In the process of lifting the devices, each operation link should be carried out according to the following requirements:

- The devices should be lifted vertically, and no dragging on the ground or the top of the cabinet should occur when lifting, and the devices should not be dragged on any surface.
- The devices should be suspended after being lifted 300 mm from the supporting surface. Check the connection between the lifting tools and the devices. Lift only after confirming that the connection is firm.
- After the devices are in place, they should be put down gently and steadily. It is strictly forbidden to place the devices in a vertical place by shaking the lifting tools./
- The place where the devices are placed should be solid and flat, with good drainage, without obstacles or protrusions.

## 5.5. Tools

The following tools may be required during the installation process :



Marker

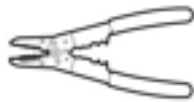

Wire Stripper



Phillips Screwdriver Bit



Torx screwdriver Bit



Flat-Head Screwdriver



Hydraulic pliers



Drill



Tape Measure



Lifting device



Forklift



Torque Wrench



Network Wire Clamp



hot wind



Cylinder Screwdriver



Multimeter

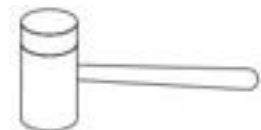

Rubber Mallet

## 5.6. Safety Gear

Wear the following safety gear when dealing with the battery system.



Dust Mask



Safety Goggles



Safety Gloves



Safety Shoes

## 5.7. Additionally Required Installation Materials (Not Included In the Scope of Delivery)

- a) Live wire, neutral wire, and earth wire of external mains \*1 10 AWG/6 mm<sup>2</sup>
- b) Network cable \*3 CAT5 or CAT5 higher
- c) Power cable to inverter \*2 3 AWG/25 mm<sup>2</sup>
- d) PE cable 6 AWG/16 mm<sup>2</sup>
- e) OT terminal suitable for M6 screw
- f) M6 screw
- g) Heat shrink tubing

## 5.8. Fixed Installation

Positions need to be fixed at the bottom of the cabinet are marked in the drawing below.

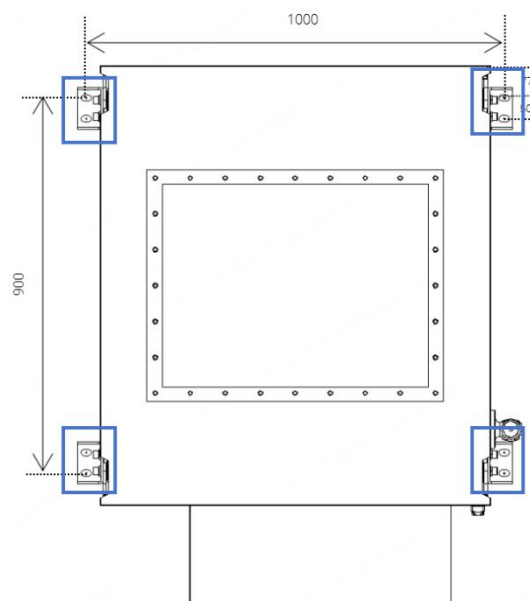

### 5.8.1. Drilling the Holes

1. Use a lifting device to hoist the battery cabinet to or use a forklift to move the battery cabinet to the intended location.
2. Drill the holes at the position marked in the right drawing below.

Note: there are 8 holes need to be drilled. The hole diameter must match the expansion screw (M12×70). (M16 drill bit is recommended)

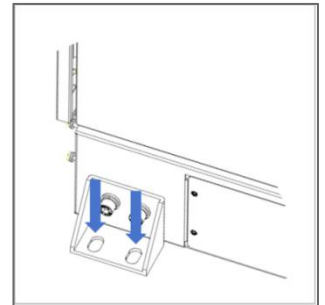

### 5.8.2. Installing the Expansion Screws

1. Insert the eight screw anchors into the drilled holes if the support surface requires them.
2. Secure the angle steel using screws (M12x70).
3. Tighten the four angle steel using a sleeve electric screwdriver (bit model A/F19) (Torque: 70 Nm).

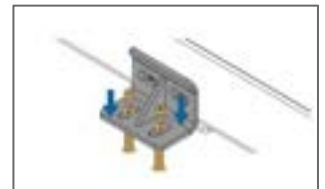

**Note:** If the foundation is not flat, loosen the angle steel on the cabinet, pre-tighten the expansion bolts, tighten the angle steel on the cabinet, and finally tighten the expansion bolts.

### 5.9. Adjust the Direction of the Alarm Light

The alarm light is facing downward by default. You need to loosen the M5 screws that secure the alarm light first, then rotate the alarm light upward, and then tighten the M5 screws with a Torx electric screwdriver (T25) (Torque: 5 Nm).

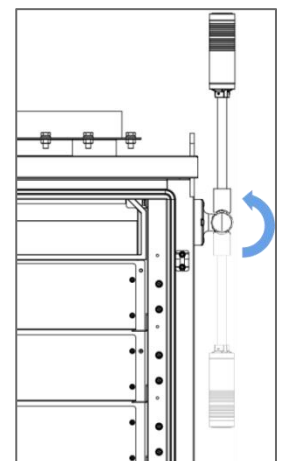

## 5.10. Open the Door

Open the door before installation.

### Procedure:

1. Insert the door key and turn it clockwise until the door handle pops out.
2. Pull the door handle upward until the door opens.



## 5.11. Remove the Deflector Panel

The deflector panel needs to be removed with a phillips electric screwdriver (PH2) if more than 4 battery modules will be installed.

There are 8 pre-installed deflector panel. The number of deflector panel that need to be removed depends on the number of battery modules will be installed.

Note: Make sure there are no deflector panel behind the shelves where the battery modules will be installed.

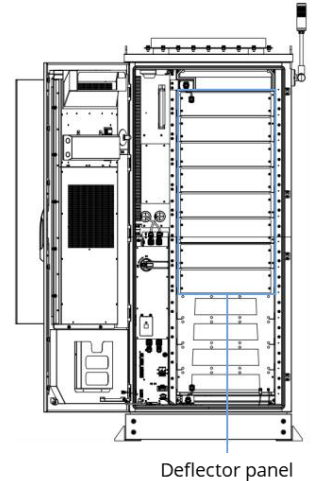

## 5.12. Installing the Battery Modules

### 5.12.1. Notes for Unpacking and Handling the Battery Module

Before unpacking the battery module, please check whether the packaging and battery module are damaged. If damaged, please contact BYD or BYD authorized service partner.

#### CAUTION

- One battery module weight is about 75 kg.
- When moving the module, prevent the module from falling and being damaged.
- It is recommended to use a lift device to move and install the battery module(s).
- During the operation, be sure to wear safety gears, such as safety shoes, safety helmets, protective gloves, etc.

### 5.12.2. Measure the Voltage of All the Battery Modules

#### ⚠ QUALIFIED PERSON

Before installing the battery modules, please measure the voltage of each battery module and record it in the **checklist**, which can be see in Appendix 2.

Refer to the following table to find out the SOC corresponding to the above measured voltage. Only when the SOC difference of all battery modules is within 5% can be installed. otherwise, it is not allowed.

SOC	23%	24%	25%	26%	27%	28%	29%	30%	31%	32%	33%
Voltage/V	78.96	79.1	79.2	79.22	79.3	79.34	79.38	79.42	79.42	79.44	79.44

### 5.12.3. Install the Battery Module

#### ⚠ QUALIFIED PERSON

A cabinet supports up to 12 modules, and at least 4 battery modules need to be installed (from bottom to top).

Please use the handle on the side to carry the battery module to suitable height, and then push the module into the shelf.

**Note:** When pushing the battery module, please protect the battery module from hitting the cabinet to prevent damage.

After pushing the battery module in, the four holes on the module mounting ears will align with the screw holes on the cabinet. Please fix them with four M6\*16 screws with a sleeve electric screwdriver (bit model A/F10) (Torque: 7 Nm).

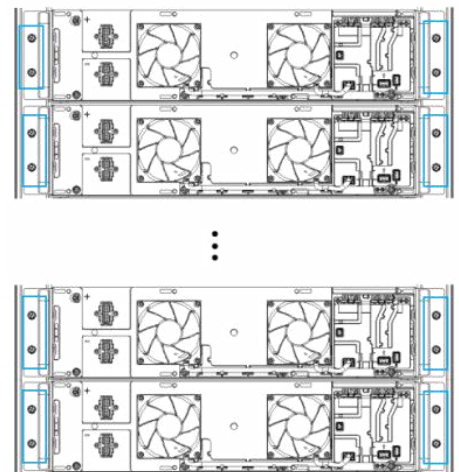

### 5.13. Adjust the Position of the Positive Power Cable Junction Kit

The position of the positive power cable junction kit only needs to be adjusted if less than 12 battery modules have been installed.

1. Unscrew four M4 screw with a phillips electric screwdriver (PH2) refer to the right drawing and remove the panel.
2. Unplug the B+ cable connector.

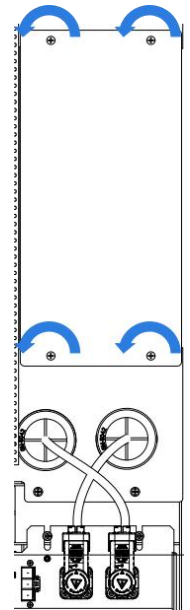

3. Unscrew the M6\*16 screws of the positive power cable junction kit with a sleeve electric screwdriver (bit model A/F10).
4. Hold the positive power cable junction bit and pull out the B+ cable. Then pass the B+ cable through the hole on the upper left of the top module and then out through the B+ cable hole. Plug the B+ cable connector to corresponding port.
5. Secure the positive power cable junction bit with a sleeve electric screwdriver (bit model A/F10) (Torque: 7 Nm).
6. Secure the four M4 screws with a phillips electric screwdriver (PH2) ((Torque: 2.5 Nm).

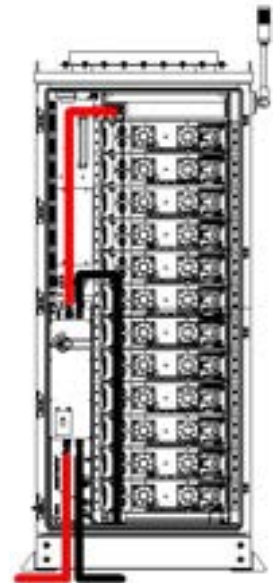

## 6. Electrical Connection

### 6.1. Precautions

#### DANGER

##### **Danger to life due to electric shock when live components or DC cables are touched**

The DC cables connected to an inverter may be live. Touching live DC cables results in death or serious injury due to electric shock.

- Disconnect the battery system and inverter from voltage sources and make sure it cannot be reconnected before working on the device.
- Do not touch non-insulated parts or cables.
- Do not remove the terminal block with the connected DC conductors from the slot under load.
- Wear suitable personal protective equipment for all work on the battery system.
- Observe all safety information of the inverter manufacturer.

#### DANGER

##### **Danger to life due to electric shock in case of overvoltage and if surge protection is missing**

Overvoltage (e. g., in the event of a flash of lightning) can be further conducted into the building and to other connected devices in the same network via the network cables or other data cables if there is no surge protection. Touching live parts and cables results in death or lethal injuries due to electric shock.

When laying the network cables or other data cables outdoors, it must be ensured that a suitable surge protection device is provided at the transition point of the cable from the battery system or the inverter outdoors to the inside of a building.

#### WARNING

- Check and ensure that the polarity of all input cables is correct before wiring.
- Do not forcibly pull any wires or cables during electrical installation, as this may compromise the insulation performance.
- Ensure that all cables and wires have sufficient space for any bends.
- Adopt the necessary auxiliary measures to reduce the stress applied to cables and wires.
- Check carefully that the connection is correct and secure after completing each connection.

## NOTICE

**Damage to the electrical equipment in the cabinet, or impair their functionality due to sand, dust and moisture ingress.**

- Only open the cabinet if the humidity is within the thresholds and the environment is free of sand and dust.
- Perform electrical connection when there is no sandstorm and the weather is fair and dry.

## 6.2. Preparation before Wiring

### 6.2.1. Procedure for Assembling the External Cable Glands

#### **⚠ QUALIFIED PERSON**

There are 6 pre-assembled external cable glands.

#### **Overview:**



1	Small nut
2	Gasket
3	Main body
4	Waterproof ring
5	Large nut
6	Plug

#### **Procedure:**

1. Detach all the part of the external cable gland.

- Pass the cable through the large nut, waterproof ring, main body, gasket, wiring hole and small nut from bottom to top refer to the right drawing.

**Note:**

- Make sure the body is below the wiring hole.
- There is a slit on the side of the waterproof ring, and the cable can be pressed directly into it from the side.

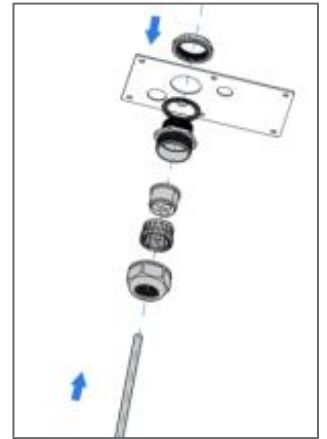

- Insert the main body into the wiring hole and tighten the small nut.

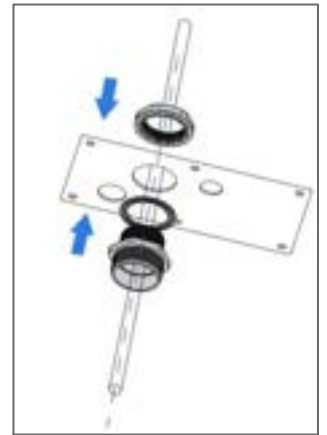

- Insert the waterproof ring into the main body and tighten the large nut.

**Note:**

- The remaining five external cable glands are installed in the same procedure.
- If an external cable gland is not used, please make sure the hole is well covered by the plug before finishing installation. otherwise, the water has the possibility to get inside of the cabinet.

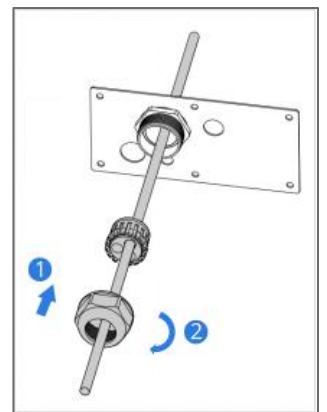

**Overview of the wiring hole:**

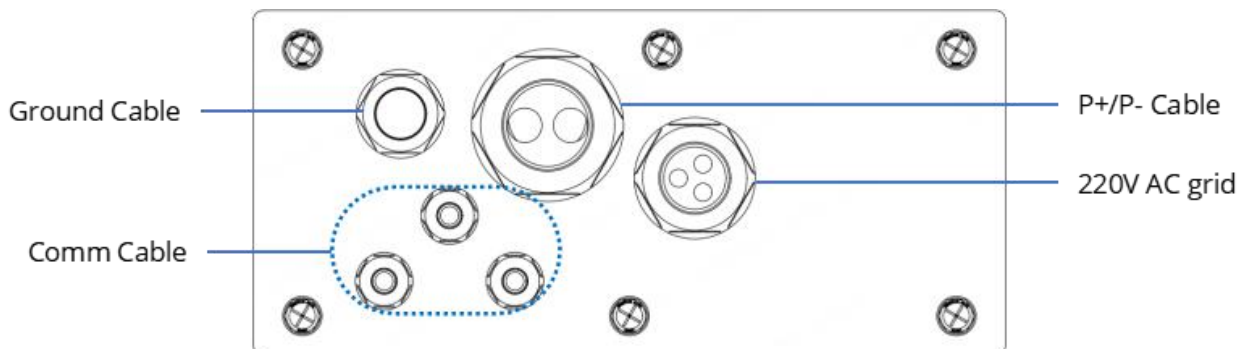

### 6.3. Connecting a Ground Cable for the Cabinet

#### ⚠ QUALIFIED PERSON

#### NOTICE

Ground the product strictly following local standards and regulations.

To ensure safety and avoid electric shock, please connect the ground cable first.

#### Additional required materials (not included in the scope of delivery) :

- One ground cable per cabinet

#### Cable requirements:

- Ground cable cross-section: 6 AWG/16 mm<sup>2</sup>.
- Conductor: Suitable for M6 screw.

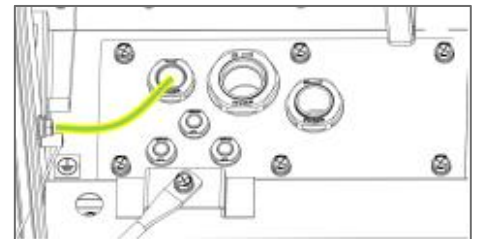

#### Procedure:

1. Strip the grounding cable and make the Length (L on the following drawing) stripped 2-3 mm longer than the tube of the conductor (E on the right drawing).

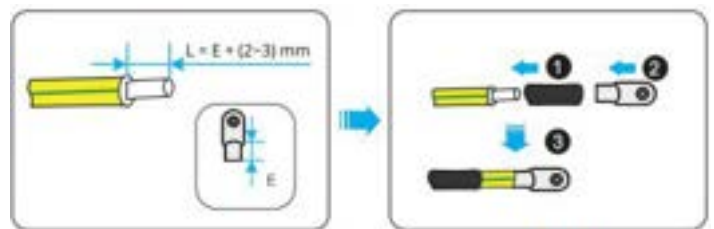

2. Get the cable through the heat shrink tubing and plug the conductor on the cable.

3. Squeeze the tube of the conductor with a pair of crimping pliers.

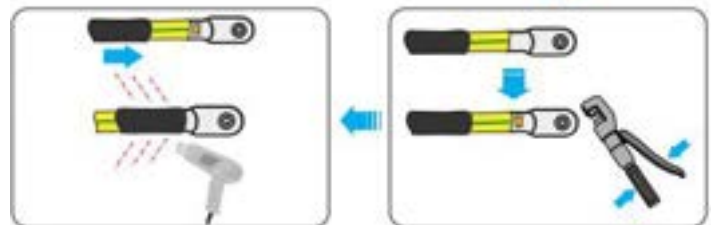

4. Get the heat shrink tubing back to cover the connection part of the cable and the conductor.

5. Blow the heat shrink tubing with hot wind.

6. Put the ground cable through the wiring hole and assemble the external cable glands according to the mentioned in section 6.2.1.

7. Secure the ground cable using M6 screw with a sleeve electric screwdriver (bit model A/F10) (Torque: 7 Nm).

## 6.4. Battery Module and PDU Wiring

Please remove the magnetic cover in front of the battery module first before making any module-related wiring.

### 6.4.1. Battery Module Connection Interface Instruction

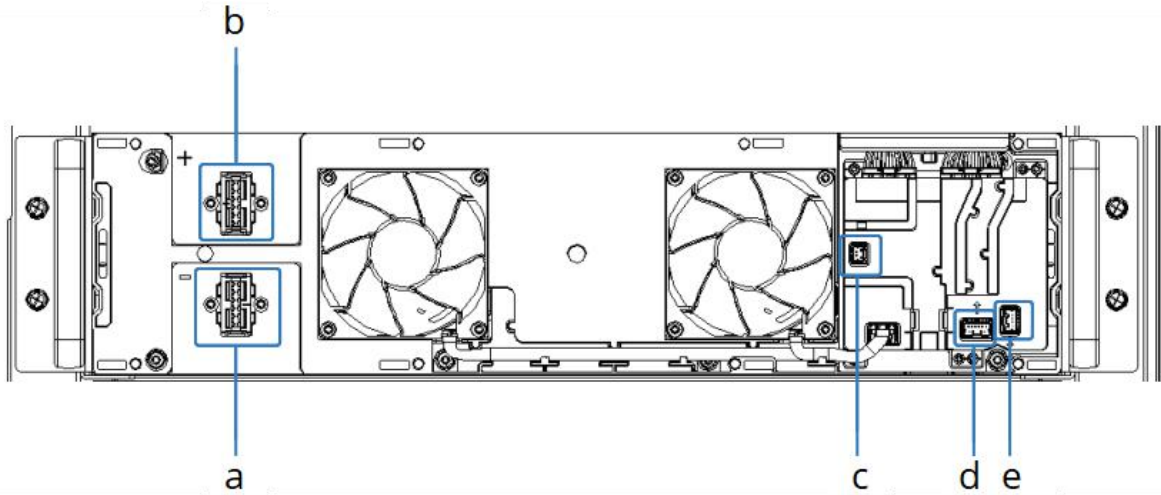

Position	Designation
a	Negative port of battery module
b	Positive port of battery module
c	Fan parallel connection port
d	BIC communication port for connecting the upper module
e	BIC communication port for connecting the lower module

## 6.4.2. PDU Connection Interface Instruction

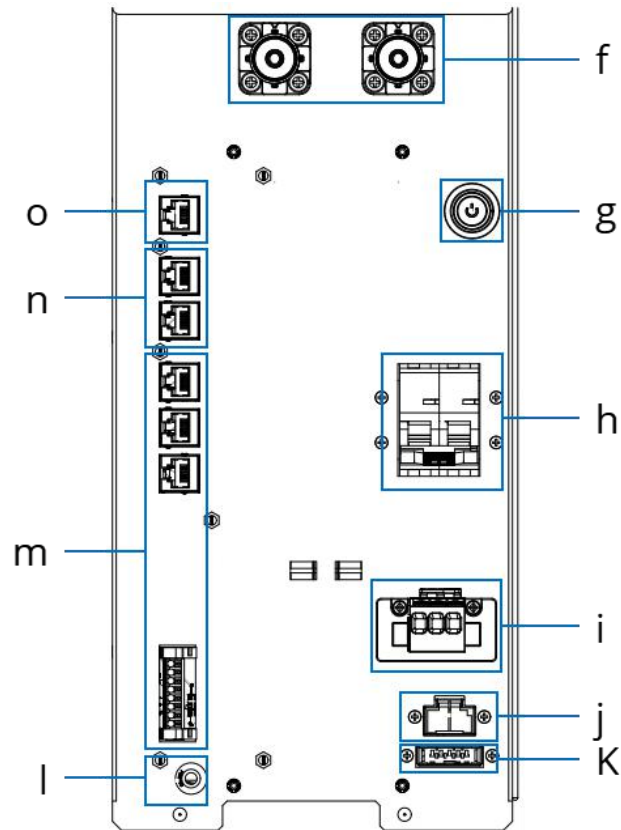

Position	Designation
f	P+/P- power cable connection port
g	LED Button
h	220 V AC breaker
i	Mains input port: live wire, neutral wire, earth wire respectively
j	Fan power supply connection port
k	BIC communication port
l	Ground cable connection port
m	The communication interface with the inverter, including RS485, CAN, Modbus TCP communication protocol interface, 8-Pin interface
n	Parallel communication interface, "IN" and "OUT" port
o	RJ45 port for Ethernet cable connection

### 6.4.3. Connect the BIC Communication Cable

#### **⚠ QUALIFIED PERSON**

1. Remove all the magnetic cover in front of the battery module.
2. Plug the BIC loop terminal (**N**, in the scope of delivery) to the top battery module **port d**.

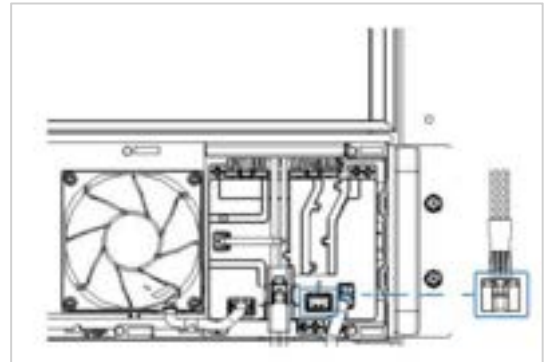

3. Connect all the BIC communication cable (**D**, in the scope of delivery) between adjacent modules in sequence.

**Note:** A cabinet can install 4-12 battery modules, and 3-11 BIC communication cables (**D**, in the scope of delivery) between adjacent modules need to be connected accordingly.

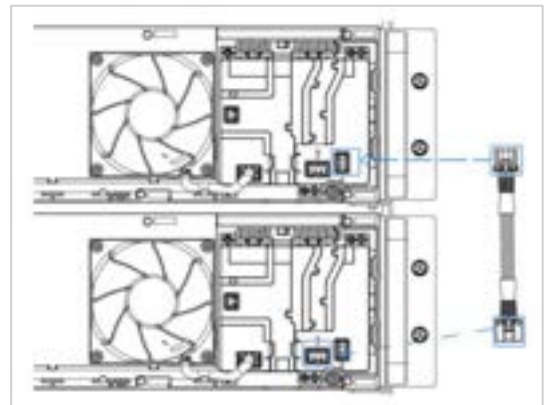

4. Plug one side of the SPI cable (**O**, in the scope of delivery) to the bottom battery module **port e**, and other side connect to the **port k** of the PDU.

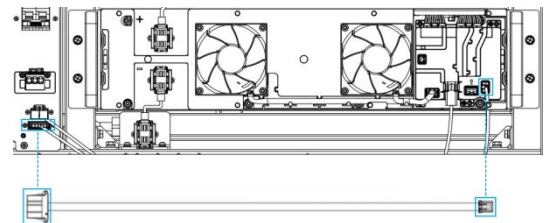

#### 6.4.4. Connect the Fan Cable

### ⚠ QUALIFIED PERSON

- 1 Plug the fan cable loop terminal (**M**, in the scope of delivery) to the top battery module **port c**.
- 2 Plug all the black plug of the fan cable 1 (**C**, in the scope of delivery) to fan parallel connection port (**port c**) according to the right drawing.

**Note:** one cabinet can install 4-12 battery modules, and 3-11 fan cable 1 (**C**, in the scope of delivery) between battery modules need to be connected accordingly.

- 3 Connect all the fan cable 1 (**C**, in the scope of delivery) between adjacent modules in sequence according to the right drawing.
- 4 Press the fan cable into the cable slot (the gray area in the right drawing).
- 5 Plug the black side of the fan cable 2 (**P**, in the scope of delivery) into the **port j** of the PDU.
- 6 Connect the other side of the fan cable 2 (**P**, in the scope of delivery) to the fan cable 1 (**C**, in the scope of delivery) of the bottom module.

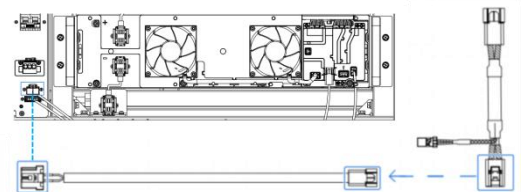
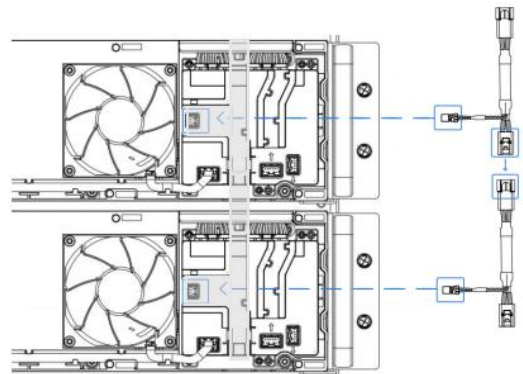

## 6.4.5. DC Connection for the Battery Modules

### ⚠ QUALIFIED PERSON

#### 6.4.5.1. Connect the Copper Bar 2 (Positive)

Connect the top battery module and positive junction kit with a copper bar 2 (positive) (H, in the scope of delivery, both end of the connectors are red).

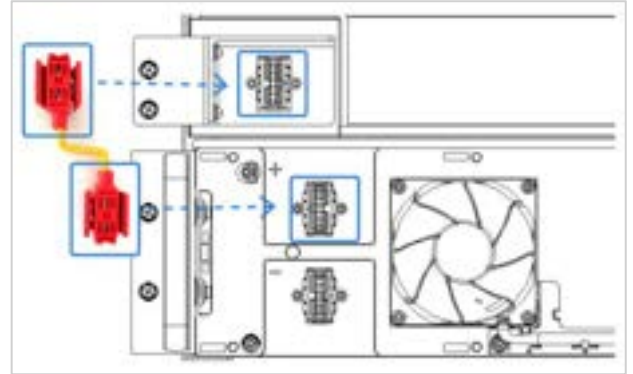

#### 6.4.5.2. Connect the Copper Bar 1 ( Adjacent Battery Modules)

The red copper bar connector represents the positive pole and the black copper bar connector represents the negative pole.

Connect the red copper bar connector to the positive terminal port of the lower module, and the black copper bar connector to the negative terminal interface of the upper module.

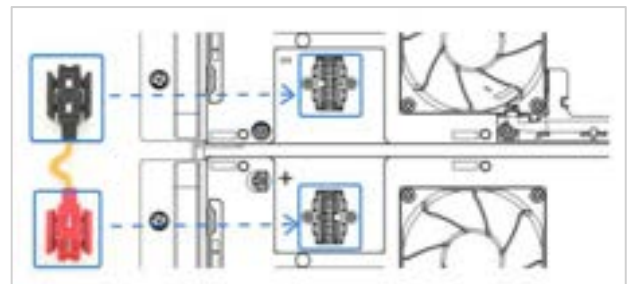

#### 6.4.5.3. Connect the Copper Bar 3 (Negative)

Connect the bottom battery module and negative power cable junction box with a copper bar (negative, both end of the connectors are black).

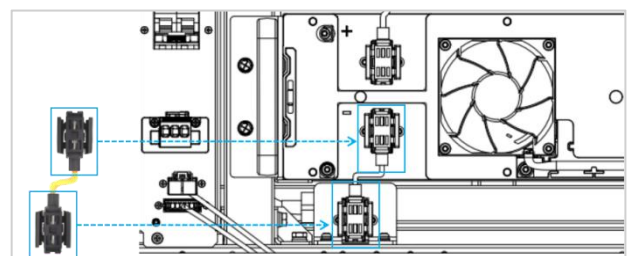

**Note:** Don't forget to reinstall all the magnetic cover when all wiring for the battery module is completed.

#### 6.4.6. Power Cable Connection

### ⚠ QUALIFIED PERSON

When two or three battery cabinets are connected in parallel, the positive power cable length of all the battery systems should be approximately equal, and so are the negative power cables. A combiner box or Y-Bridge connectors are needed to combine these cables. You can refer to Battery-Max Lite Combiner Box Basic Technical Requirement, which is also available at our website [www.bydbatterybox.com](http://www.bydbatterybox.com) or [www.bydenergy.com](http://www.bydenergy.com). Please also follow the local, state, provincial, federal, or national laws, regulations, and instructions from the inverter manufacturer to choose the right combiner box or Y-Bridge connectors.

P+ and P- are power cable connection ports, which are connected to the inverter.

#### **Additional required materials (not included in the scope of delivery) :**

- Two power cables per cabinet

#### **Power cable requirements:**

- Conductor cross-section: 3 AWG/25 mm<sup>2</sup>. The diameter of the cable should be  $10.6 \pm 0.4$  mm . Follow the requirements of the inverter manufacturer.
- Insulation stripping length: 16.5+0.5 mm.

#### **Power connector composition could see below:**

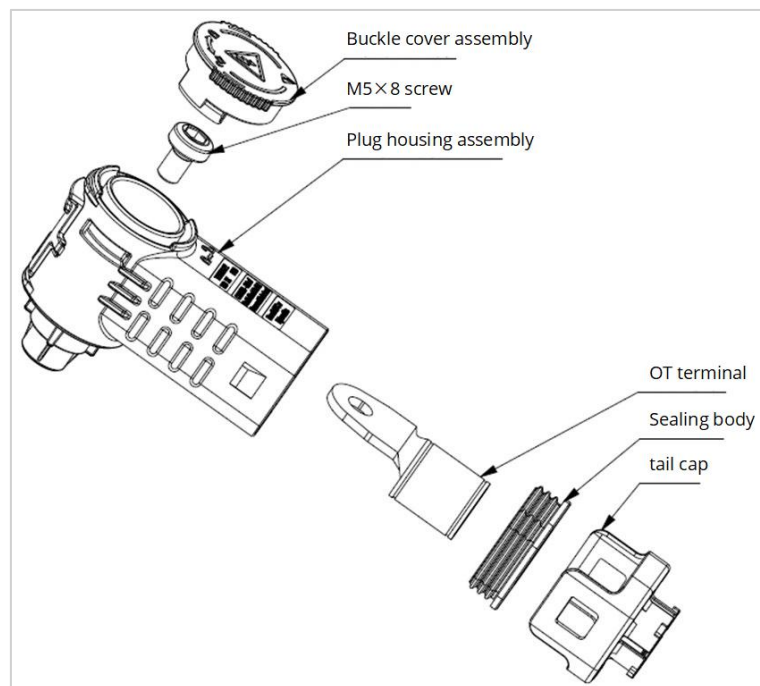

**Procedure:**

- 1. Before crimping, install the tail cap and sealing body on the wire in sequence and leave the crimping area open, as shown in right Figure.

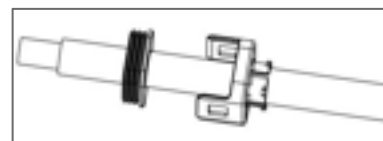

- 2. Crimp the OT terminal.



- 3. Insert the cable into the rear end of the plug housing assembly as shown in the right figure to make the bolt mounting hole of the plug housing assembly coincides with the circular hole of the OT terminal.

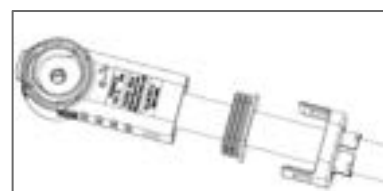

- 4. Install the sealing body and tail cap onto the housing of the plug housing assembly, making sure the tail cap is fully installed onto the housing and a "click" is heard.

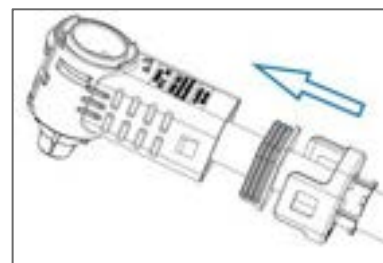

- 5. Tighten the OT terminal and the socket terminal using a M5×8 screw with a Torx electric screwdriver (T25) (Torque: 5-6Nm).

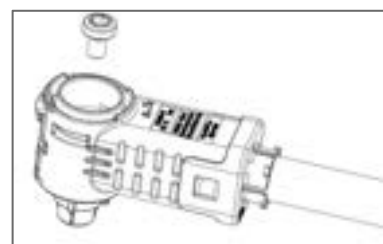

- 6. Assemble the buckle cover assembly to the plug housing assembly. Note: the buckle should correspond to the buckle groove on the housing.

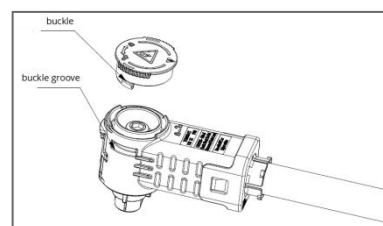

7. Tie the cable tie around the spring tabs on the tail cap.

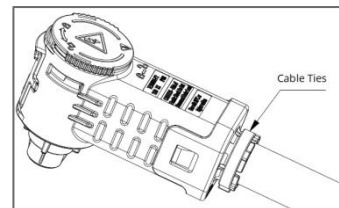

8. Plug the plug and socket together along the axis of the terminal (as shown in the right picture)

Note: Plugs and sockets can be plugged together at any angle of 360° along the axis

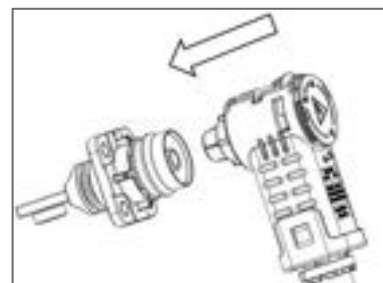

9. Push the plug until you hear a click.



10. Rotate the buckle cover so that the arrow points to the locked position, refer to the right drawing.



11. Put the power cables through the wiring hole and assemble the external cable glands according to the mentioned in section 6.2.1.

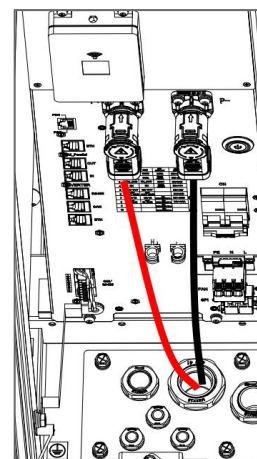

## 6.4.7. Communication Cables Connection to an Inverter

### Connection Options

The connection options with different inverters could be read in the Appendix 1.

### Additional required materials (not included in the scope of delivery) :

- One communication cable to the inverter

### Communication cable requirements:

The length and quality of the cable will affect the quality of the signal. Please observe the following cable requirements.

- Cable category: Cat5, Cat5e or higher
- Plug type: metal Shielded RJ45 of Cat5, Cat5e or higher
- Shielding: yes
- UV-resistant for outdoor use
- Straight- through wired cables
- Maximum cable length: 20 m

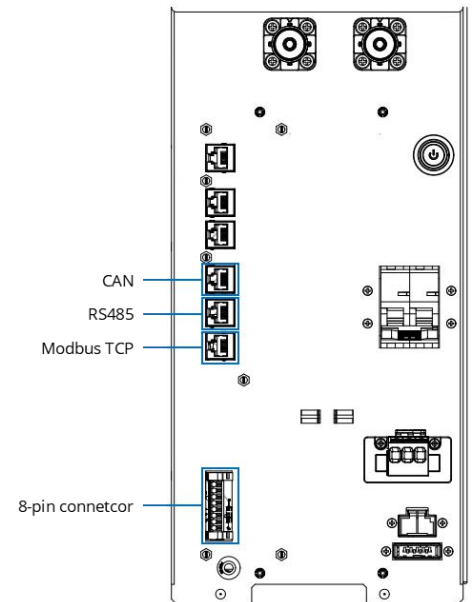

### Procedure:

1. Read the Pin designation of the communication interface of the PDU and the corresponding interface at the inverter, and decide whether to trim the communication cable.

Pin	1	2	3	4	5	6	7	8
RS485	RS485A	RS485B	EN_GND	EN	12V_OUT	12V_OUT_GND	12V_IN	12V_IN_GND
CAN	CAN H	CAN L	EN_GND	EN	12V_OUT	12V_OUT_GND	12V_IN	12V_IN_GND
CAN/RS485	CAN H	CAN L	EN_GND	EN	12V_IN	12V_IN_GND	RS485B	RS485A

**Note:** If the communication cable has to be trimmed, please apply a network wire clamp to crimp the RJ45 connector after the cable is cut and the position of wires is arranged.

2. Plug the RJ45 plug of the communication cable to the corresponding RJ45 port.
3. Put the communication cable through the wiring hole and assemble the external cable glands according to the mentioned in section 6.2.1.

### The method to plug the communication cable into the 8 pin terminal block:

1. Strip the communication cable by 50 mm.
2. Strip the insulation on the insulated conductors each by 6 mm. The CAN L and CAN H (or RS485A and RS485B) must be a twisted pair.
3. If necessary, trim unused insulated conductors flush with the cable sheath or fold it over the cable sheath.
4. Press the button with a flat-head screwdriver, as shown in the drawing.

5. Plug the conductors into the 8-pin terminal blocks. Pay attention to the assignment of the terminal block and communication connection on the inverter.
6. Make sure that the conductors are plugged into the terminal points tightly by pulling slightly on the conductors.
7. Put the communication cable through the wiring hole and assemble the external cable glands according to the mentioned in section 6.2.1.

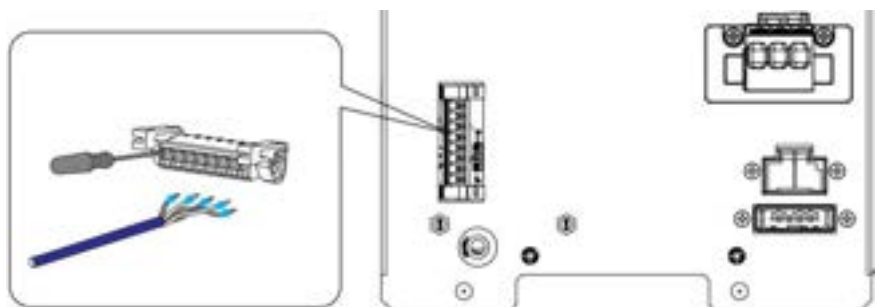

#### 6.4.8. Network Cable Connection to External Router

The connection to the internet is not mandatory, but recommended.

##### **Additional required materials (not included in the scope of delivery) :**

- One network cable

##### **Cable requirements:**

The length and quality of the cable will affect the quality of the signal. Please observe the following cable requirements.

- Cable category: Cat5, Cat5e or higher
- Plug type: metal Shielded RJ45 of Cat5, Cat5e or higher
- Shielding: yes
- UV-resistant for outdoor use
- Straight-through wired cables
- Maximum cable length: 20 m

##### **Procedure:**

1. Plug the RJ45 plug of the network cable to the corresponding RJ45 port on the PDU.
2. Put the other side of the network cable through the wiring hole and assemble the external cable glands according to the mentioned in section 6.2.1.

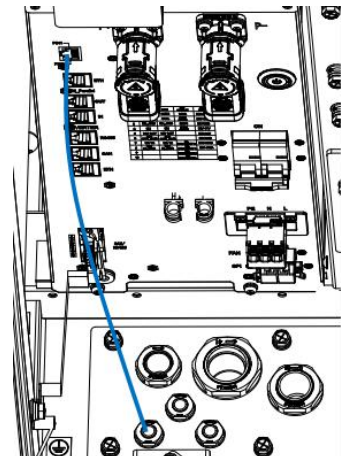

### 6.4.9. Auxiliary AC Power Supply Connection

#### ⚠ QUALIFIED PERSON

The battery system requires an auxiliary AC power supply to power the air conditioner and the fan.

Please refer to the following auxiliary AC power supply parameter requirements:

Input voltage range	AC input		90	-	264	VAC
Input frequency			47	-	63	HZ
Input current	115 VAC		-	-	12	A
	230 VAC		-	-	6	
Inrush current	115 VAC	Cold-start	-	20	-	
	230 VAC		-	40	-	
Power factor	115 VAC	Normal temperature, full load run	PF≥0.99			
	230 VAC		PF≥0.95			
Leakage current	240 VAC		<0.5 mA			

#### Additionally required mounting materials (not included in the scope of delivery):

live cable, neutral cable and ground cable

#### Cable requirements:

Conductor cross-section: 6 mm<sup>2</sup>/10 AWG.

Insulation stripping length: 16-18 mm

#### Procedure:

1. Strip the cable and make the length stripped 16-18 mm.
2. Put the cable through all the part of the external cable glands and the wiring hole.
3. Push the terminal lever of the plug and pull terminal (**L**, in the scope of delivery) up and then insert the live cable, neutral cable and ground cable into the corresponding terminal point. Ensure that the conductors are plugged completely into the terminal points all the way to the insulation.
4. Pull the terminal of the plug and pull terminal (**L**, in the scope of delivery) up lever down. Ensure that the terminal points are allocated to the correct conductors.
5. Insert the plug and pull terminal into the corresponding port i of the PDU.
6. Assembling the external cable glands according to the method mentioned in 6.2.1.

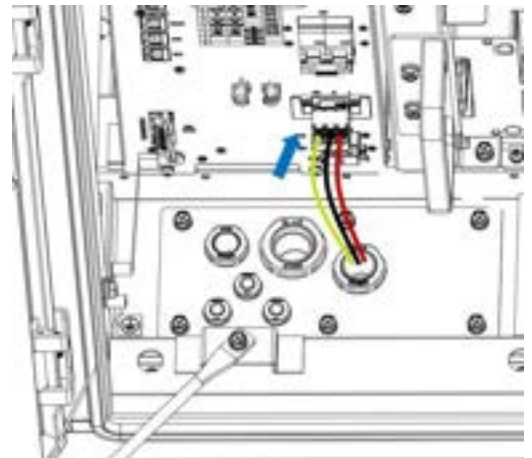

## 6.5. Close the door

1. Press the upper part of the door with your hand (as shown in the right drawing).
2. Press the door handle until the door closes.

**Note:** The battery system will only work properly when the door is closed.

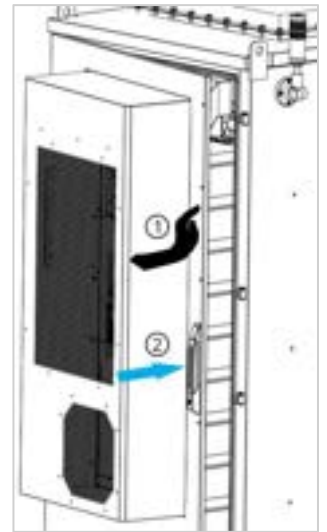

## 6.6. Install the Air Conditioning Drain Pipe

The install the air conditioning drain pipe is not mandatory, but recommended.

1. Insert the air conditioner drain pipe (**U**, in the scope of delivery) refer to the right drawing).

**Note:** The air conditioner drain outlet is located at the bottom of the air conditioner

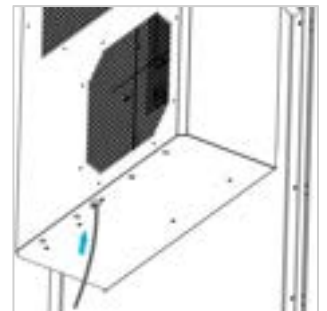

## 6.7. Install the cover

1. Install the front cover (**S**, in the scope of delivery) of the cabinet with four M6\*35 screws (**T**, in the scope of delivery) with a Torx electric screwdriver (bit model : T30) (Torque: 7 Nm).
2. Install the rear cover (**S**, in the scope of delivery) of the cabinet in the same steps.

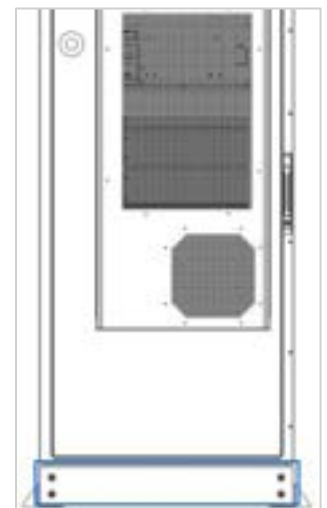

## 6.8. Parallel Communication Connection between Cabinet

### QUALIFIED PERSON

This connection could only need to be made when **2 to 32** cabinets are connected in parallel.

**The connection diagram of two battery systems could be read below.**

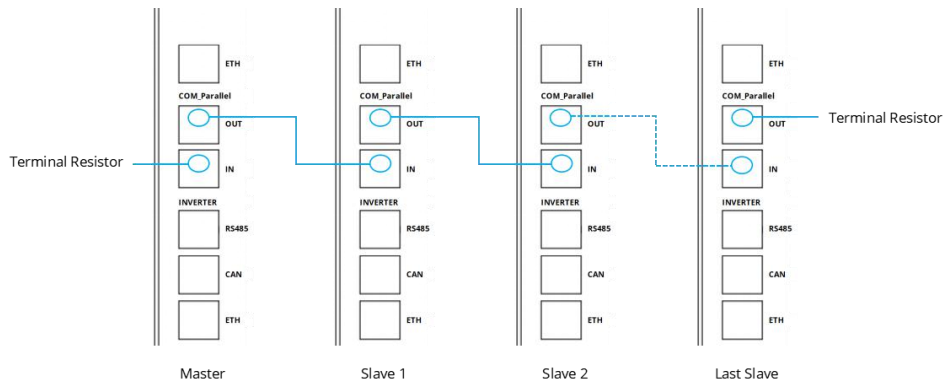

### **Additionally required materials (not included in the scope of delivery):**

One to thirty-one data cables

### **Data cable requirements:**

The length and quality of the cable will affect the quality of the signal. Please observe the following cable requirements.

- Cable category: Cat5, Cat5e or higher
- Plug type: metal shielded RJ45 of Cat5, Cat5e or higher
- Shielding: yes
- UV-resistant for outdoor use
- Straight- through wired cables
- Maximum cable length: 20 m.

### **Procedure:**

1. Plug the RJ45 plug to the **"OUT"** port of the master cabinet
2. Get the other end of the data cable without the RJ45 plug through the cable gland of the master and the first slave cabinet refer to 6.2.1. (If the data cable has two RJ45 ends, cut the cable to make sure at least one end has no RJ45 plug.)
3. Please apply a network wire clamp to crimp the RJ45 plug after the position of wires is arranged. And then plug the RJ45 plug to the **"IN"** Port of the first slave cabinet.
4. Assembling all the external cable glands according to the method mentioned in 6.2.1.
5. Follow the above steps for the remaining cabinets.

6. Plug the resistor terminal into the “**IN**” port of the master cabinet and the “**OUT**” port of the last slave cabinet.

## 7. Commissioning

### 7.1. Switch On the Battery System

**Notice:** Make sure the handle switch and air switch on the PDU is off before any commissioning operation.

**Requirements:**

- The power cable connection between the battery system and the inverter must be off.
- The inverter must be mounted correctly.
- All cables must be connected correctly.

Only after all the above requirements are confirmed, the battery system can be switched on.

**Procedure:**

1. Switch on the the air switch between the battery system and the inverter if there is any.
2. Rotate the handle switch 90° clockwise.
3. Press the button on the PDU for 3 seconds.
4. Switch on the air switch on the PDU.
5. The alarm light will be solid red for a while, and then turns solid green, which means the battery system is ready to work.
6. If the alarm light is blink green, it means there are some alarm occurs, but no affect the normal operation of the battery system.
7. If it failed to switch on the battery system, please read Chapter 10 Troubleshooting and also the Service Manual. **IF THE PROBLEM STILL CANNOT BE SOLVED, CONTACT OUR LOCAL AFTER-SALE SERVICE TEAM WITHIN 48 HOURS.**

## 7.2. Configuration

### QUALIFIED PERSON

#### Procedure

1. Download the **BYD Max Lite** from Google Play or APP Store. The battery system requires the latest version of firmware to operate. So please make sure you have downloaded the latest firmware in your device (cell phone, iPad, etc.), or your device could access the internet during configuration.
2. Check the box in front of "I agree to the Privacy Policy", and then tap the "Start" button.
3. The app will check the firmware, and download it when the internet is available. If there is no internet available, you can tap "Skip" to skip the firmware checking.
4. After downloading the firmware, tap the button "Check WIFI Settings to connect the Wi-Fi of the battery, which begins with "BYD-", and the full name could be found at the label on the PDU.
5. The app will update the firmware automatically. After that, a notice will pop up. Tap "Yes" if you need to configure the battery system, and then tap "Next" on the "Time Confirm" page.



6. Choose the inverter brand which is going to operate together with the battery system.

**Notice:** If the inverter brand is "Kaco" or "SMA", there will be two more configurations of "IP" and "Port".

**IP:** the static IP address of the battery

**Port:** the TCP service port number of the battery

1. If the inverter brand is "SMA", the suggested configuration is as follows:

**Inverter:** SMA\_CML

**IP:** 192.168.12.131~192.168.12.254

**Port:** 502

2. If the inverter brand is "Kaco", the suggested configuration is as follows:

**Inverter:** KACO/SMART1

**IP:** The same network segment as the router

**Port:** 502



7. Tap "configuration" and a notice of "successfully configured" will pop up. Tap "OK" and the APP will jump to the battery information homepage.



8. If there is a problem, go back and do the configuration again.

**Note:**

1. Restart the **BYD Max Lite** if the App has a problem.

2. Please note that the SOC of the battery may not be accurate until a full charge and discharge cycle after the configuration is completed.

### 7.3. Switch On and Commission the Inverter

**Procedure:**

1. Mount and connect the inverter according to the inverter manufacturer's instruction.
2. Switch on the inverter.
3. Configure the inverter and do the commissioning according to the inverter manufacturer's instruction.

If the battery information could be read correctly at the inverter, it means the connection is all right.

If the alarm light is blinking green, it means there is an alarm, but does not affect the normal operation of the battery system.

If the alarm light is solid red, and/or there are some battery errors shown at the inverter, please refer to Chapter 11 Troubleshooting of this manual and also read the Service Manual.

## 8. Operation

### 8.1. Switch On the Battery System

To make sure the battery system can work well with the inverter, please follow the right procedure to start them.

The procedure is:

1. Switch on the the air switch between the battery system and the inverter if there is any.
2. Rotate the handle switch 90° clockwise.
3. Press the button on the PDU for 3 seconds.
4. Switch on the air switch on the PDU.
5. Switch on the inverter.

**Note: Please switch on all the battery systems in sequence, when multiple cabinets are connected in parallel**

### 8.2. Switch Off the Battery System

**Procedure:**

1. Switch off the inverter.
2. Switch off the air switch on the PDU.
3. Press the button on the PDU for 5 seconds.
4. Rotate the handle switch 90° counterclockwise.
6. Switch off the the air switch between the battery system and the inverter if there is any.

**Note: Please switch off all the battery systems in sequence, when multiple cabinets are connected in parallel**

### 8.3. Black Start Function

The battery system supports the black start function of compatible inverters. Press LED button for around 3 second while the system is on can enable this function.

If two or thirty-two battery cabinets are connected in parallel, only the LED button on the master system needs to be pressed.

The ways to trigger that are different for different inverters. Please follow the inverter manufacturer's instructions here.

### 8.4. Wi-Fi

Restart the system or press the LED button for around one second while the system is on if the Wi-Fi is disappeared could activate the Wi-Fi again.

Press the LED button three times (each time around one second) within six seconds could reset the Wi-Fi.

## 8.5. Air Conditioning Working Strategy

### 8.5.1. Cooling Mode

Cooling start temperature: 35°C

Cooling stop temperature: 28°C

When the internal temperature of the cabinet is higher than the cooling start temperature, the cooling mode is on. When the cabinet temperature is lower than the cooling stop temperature, the cooling mode is ended.

### 8.5.2. Heating Mode

Heating start temperature: 10°C

Heating stop temperature: 15°C

When the internal temperature of the cabinet is lower than the heating start temperature, the heating mode is on. When the cabinet temperature is higher than the heating stop temperature, the heating mode is ended.

**Notice: The air inlet temperature is measured as the temperature inside the cabinet.**

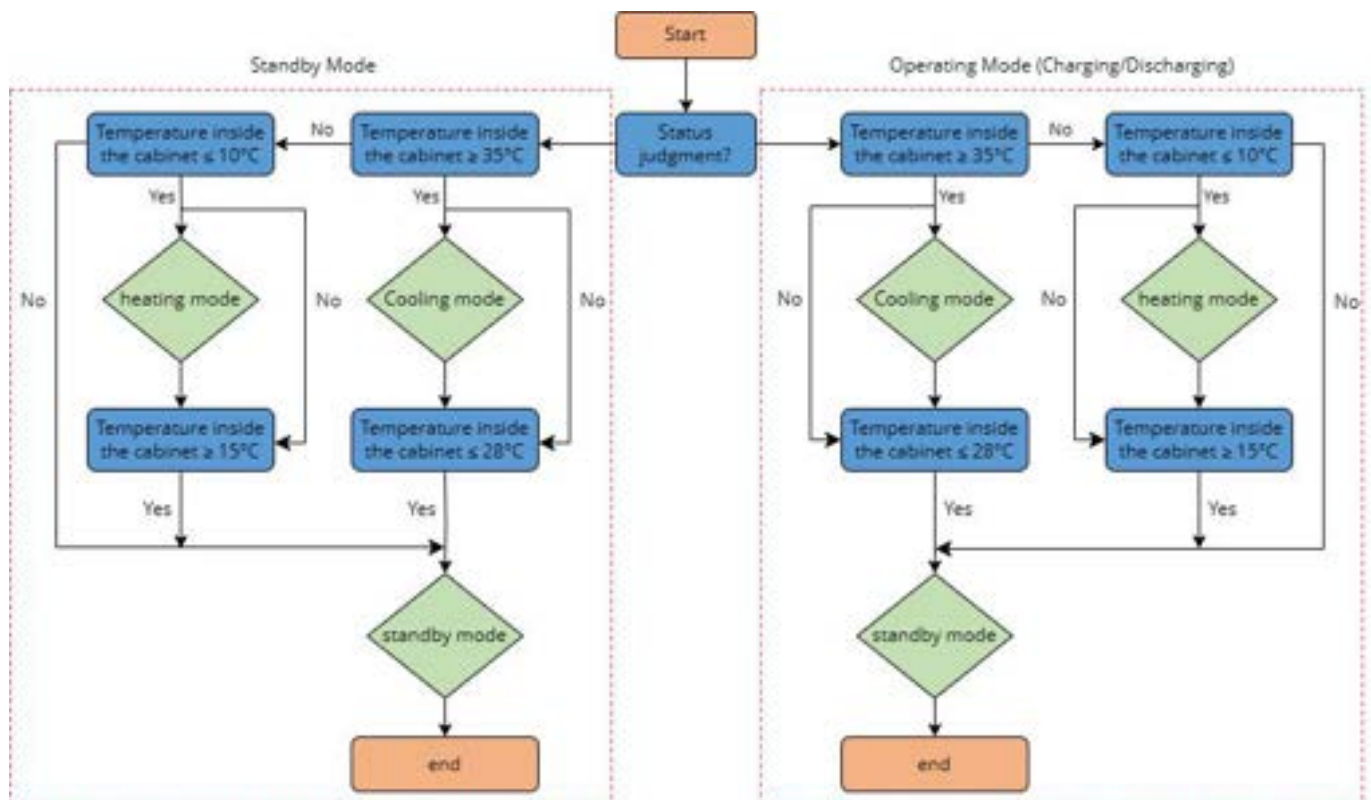

## 8.6. Fan Working Strategy

Battery cell temperature ( $^{\circ}\text{C}$ )	$\leq 15$	(15,35)	$\geq 35$
Fan control logic	Full speed	Stop	Full speed

**Note:** The priority of the air conditioning is higher than the fan. The battery cell temperature is based on the NTC detection temperature of the module.

## 9. Decommissioning

### DANGER

#### **Danger to life due to electric shock when live components or DC cables are touched**

The DC cables connected to an inverter may be live. Touching live DC cables results in death or serious injury due to electric shock.

- Disconnect the battery system and inverter from voltage sources and make sure it cannot be reconnected before working on the device.
- Do not touch non-insulated parts or cables.
- Do not remove the terminal block with the connected DC conductors from the slot under load.
- Wear suitable personal protective equipment for all work on the battery system.
- Observe all safety information of the inverter manufacturer.

### DANGER

#### **Danger to life due to electric shock in case of overvoltage and if surge protection is missing**

Overvoltage (e. g., in the event of a flash of lightning) can be further conducted into the building and to other connected devices in the same network via the network cables or other data cables if there is no surge protection. Touching live parts and cables results in death or lethal injuries due to electric shock.

When laying the network cables or other data cables outdoors, it must be ensured that a suitable surge protection device is provided at the transition point of the cable from the battery system or the inverter outdoors to the inside of a building.

#### **Procedure:**

1. Switch off the battery system following the procedures in **section 7.2**.
2. Take off the nuts on the external cable glands.
3. Remove all cables from the battery modules and the PDU.
4. Remove all the battery modules from the cabinet.

If the battery system is to be stored or shipped, pack the system. Use the original packaging or packaging that is suitable for the weight and dimensions of the system.

Dispose of the battery system in accordance with the locally applicable battery disposal regulations for electronic waste.

## 10. Extension

The SOC of the original battery system and the new battery module should be similar before the new battery module is added to the original battery system.

**Note: Within 5 days before extension, it is recommended to fully charge the original battery system to 100% SOC.**

### Procedure:

1. Measure the voltage of the new battery module with a multimeter, get a value (X).



2. Refer to the following table to find out the SOC (Y) corresponding to the X.

Voltage(X)/V	$X < 75.8$	$75.8 \leq X < 77.52$	$77.52 \leq X < 78.1$	$78.1 \leq X < 78.6$	$78.6 \leq X < 79.2$	$79.2 \leq X < 79.4$
SOC (Y)	0-5%	5-10%	10-15%	15-20%	20-25%	25-30%

3. Charge or discharge the original battery system until the SOC is almost equal to Y.
4. Switch off the battery system following the procedures in section 7.2.
5. Adjust the position of the positive cable junction box.
6. Add the new battery module(s) and connect all the required cables.
7. Switch on the battery system following the procedures in section 7.1.

## 11. Troubleshooting

If a fault occurs, the alarm light will be red, if the alarm light is green it means the battery is working properly.

Please also see the BYD Battery-Max Lite Service Manual for troubleshooting. The latest version is available at our website: [www.bydbatterybox.com](http://www.bydbatterybox.com) or [www.bydenenergy.com](http://www.bydenenergy.com).

BYD service team can get the error messages of the battery system through the remote server. With the information uploaded to the remote server can help to identify the issues. It is highly recommended to connect the battery system to the internet.

The app (**BYD Max Lite**) and PC application (**BYD Max Lite Plus**) can display battery errors (refer to section 3.7 for more information regarding these tools.)

## 12. Maintenance and Storage

### 12.1. Cleaning

It is recommended that the battery system be cleaned periodically. If the enclosure is dirty, please use a soft, dry brush or a dust collector to remove the dust. Liquids such as solvents, abrasives, or corrosive liquids should not be used to clean the enclosure.

### 12.2. Storage

- To prevent possible condensation or its bottom from being soaked by rain water in the rainy season. The battery system should be stored on higher ground.
- Raise the cabinet foundation due to site conditions. The specific height should be reasonably determined based on site geological and meteorological conditions.
- Store the battery system on a dry, flat, and stable ground with sufficient carrying capacity and without any vegetation cover.
- Before storage, ensure that the doors of the cabinet and all internal equipment are locked.
- Long-term storage of batteries is not recommended because it may cause the decrease in battery capacity. Even if the battery is stored at the recommended storage temperature, irreversible capacity degradation will still occur over time. The longer it has been stored, the greater the capacity degradation.
- The relative humidity should be between 0~95%, without condensation.
- The air inlet and outlet of the cabinet should be effectively protected to prevent rain water, sand and dust from penetrating into the cabinet.
- Carry out periodic inspections. Check the cabinet and the inner equipment for damage at least every two weeks.
- Before installing a cabinet that has been stored for more than six months, open the door to visually check and ensure that there is no condensation. Check the cabinet and the inner equipment for damage. Check the product after it is powered on and starts. If necessary, request professionals for testing before installation.
- The battery module should be stored in an environment with a temperature range between -20°C~+50°C, and charged regularly according to the table below with no more than 0.5 C (C-rate is a measure of the rate at which a battery is charged and discharged relative to its maximum capacity) to the SOC of 30% after a long time of storage.

Storage environment temperature	Relative humidity of the storage environment	Storage time	SOC
Below -10°C	/	Not allowed	/
-10~25°C	5%~70%	≤ 12 months	25%≤SOC≤60%
25~35°C	5%~70%	≤ 6 months	25%≤SOC≤60%
35~50°C	5%~70%	≤ 3 months	25%≤SOC≤60%
Above 50°C	/	Not allowed	/

## 12.3. Maintenance

### 12.3.1. Precautions Before Maintenance

 <b>WARNING</b>
<p>Do not open the door to maintain the device in rainy, humid or windy days. BYD shall not be held liable for any damage caused by violation of the warning.</p> <p>Avoid opening the cabinet door when the humidity is high in rain, snow or fog, and make sure that the seals around the cabinet door do not curl when the door is closed.</p>

 <b>WARNING</b>
<p>To avoid electric shock, do not perform any other maintenance operations beyond this manual.</p>

### 12.3.2. Maintenance Item and Period

#### 12.3.2.1. Maintenance (Every Two Years)

Item	Check method
System status and cleaning	<p>Check the following items, and correct immediately those failing to meet the relevant requirements:</p> <ul style="list-style-type: none"><li>• Check whether there is any damage or deformation of the cabinet and internal devices.</li><li>• Check if there is abnormal noise during operation of internal devices.</li><li>• Check whether the temperature in the cabinet is excessively high.</li><li>• Check whether the humidity and the amount of dust inside the cabinet are within the normal range. Clean the equipment if necessary.</li><li>• Check whether the air inlet and outlet of the device are blocked.</li></ul>
Warning marks	<p>Check whether the warning labels and marks are clearly visible and free of stains and damage. Replace them if necessary.</p>
Ground of the shielded layer of cables	<p>Check whether the cable shielding layer is in good contact with the insulation sleeve and whether the copper bus bar is firmly fixed.</p>
Corrosion	<p>Check whether there is oxidation or rust inside the cabinet.</p>

### 12.3.2.2. Maintenance (Once a Year)

Item	Check method
Outside the cabinet	<p>Check the following items, and correct immediately those failing to meet relevant requirements:</p> <ul style="list-style-type: none"> <li>• Check whether there are flammable objects on the top of the cabinet.</li> <li>• Check whether the welding points between the cabinet and the foundation steel plate are firm and whether there is corrosion.</li> <li>• Check whether there is any damage, flaking paint or sign of oxidization on the enclosure.</li> <li>• Check whether the lock of the cabinet door can be unlocked flexibly.</li> <li>• Check whether the sealing strip is fixed properly.</li> </ul>
Inside the cabinet	<p>Check whether there are foreign objects, dust, dirt, and condensed water inside the integrated cabinet.</p>
Air inlet and outlet	<p>Check the temperature of the radiator and the amount of dust accumulated. Clean heat-dissipation modules with a vacuum cleaner if necessary.</p>
Wiring and cable layout	<p>Completely power off the devices inside the system before checking. For any discrepancy found during inspection, correct them immediately.</p> <ul style="list-style-type: none"> <li>• Check whether the cable layout is normal and whether there is a short circuit. For any discrepancy found during inspection, correct them immediately.</li> <li>• Check whether all cable entry are well sealed.</li> <li>• Check whether there is water seepage inside the device.</li> <li>• Check whether the power cables are loose, and fasten them again by the torque specified previously.</li> <li>• Check whether the power cables and data cables are damaged, especially if the surface contacting the metal surface is cut.</li> </ul>
Fan	<ul style="list-style-type: none"> <li>• Check the running status of fans.</li> <li>• Check whether fans are blocked.</li> <li>• Check if there is abnormal noise during operation of the fans.</li> </ul>
Screw	<ul style="list-style-type: none"> <li>• Check whether internal screws are in place.</li> </ul>

### 12.3.2.3. Maintenance (Every Six Months to Once a Year)

Item	Check method
Safety function	<ul style="list-style-type: none"><li>• Check whether the <b>emergency stop button</b> works normally.</li><li>• perform a shutdown and restart.</li><li>• Check the warning marks and other device marks, and replace them timely when they are fuzzy or damaged.</li></ul>
Internal components inspection	<ul style="list-style-type: none"><li>• Check the cleanness of the circuit board and other elements and components.</li><li>• Check the amount of dust accumulated. Clean heat-dissipation modules with a vacuum cleaner if necessary.</li></ul> <p><b>Note!</b> It is necessary to check ventilation of the air inlet. Otherwise, fault may occur due to overheating if the battery module cannot be cooled effectively.</p>
Device maintenance	<ul style="list-style-type: none"><li>• Carry out regular inspection for corrosion of all metal components (once per half a year).</li><li>• Check the AC breaker, handle switch annually to ensure the good mechanical operation.</li><li>• The fan is a wearing part and it is recommended that it is replaced when abnormalities are found.</li></ul>

### **13. Disposal of the Battery**

Disposal of the battery must comply with the local applicable disposal regulations for electronic waste and used batteries.

- Avoid exposing the batteries to high temperatures.
- Avoid exposing the batteries to high humidity or corrosive atmospheres.
- All requirements for safe transport of the battery must be observed.
- Batteries may only be disposed of in accordance with the regulations for used batteries valid at the time of disposal.
- There is a legal obligation to return used batteries. Batteries must not be disposed as with household waste.
- Used batteries may contain harmful substances which may harm the environment or your health if not properly stored or disposed of.
- Batteries contain important raw materials, such as iron, zinc, manganese, copper, or nickel, and can be recycled.
- For more information or to arrange a collection please contact BYD Service Partner (see contact details at the bottom of this document).

## 14. Contact Information

Note: Please also see the Battery-Max Lite Service Manual for troubleshooting. The latest version is available at our website: [www.bydbatterybox.com](http://www.bydbatterybox.com) or [www.bydenenergy.com](http://www.bydenenergy.com).

<b>BYD Global Service</b>	
Email	<a href="mailto:bboxservice@byd.com">bboxservice@byd.com</a>
Telephone	+86 755 89888888-47175
Address	No.3009, BYD Road, Pingshan, Shenzhen, 5118118, P. R. China
Website	<a href="http://www.bydbatterybox.com">www.bydbatterybox.com</a> / <a href="http://www.bydenenergy.com">www.bydenenergy.com</a> <a href="https://www.facebook.com/BatteryBoxBYD">https://www.facebook.com/BatteryBoxBYD</a>
Social Media Link	<a href="https://x.com/BYD_BatteryBox">https://x.com/BYD_BatteryBox</a> <a href="https://www.linkedin.com/company/byd-batthey-box">https://www.linkedin.com/company/byd-batthey-box</a>
<b>Europe EFT-Systems GmbH</b>	
Email	<a href="mailto:service@eft-systems.de">service@eft-systems.de</a> +49 9352 8523999
Telephone	+44 (0) 2037695998 (UK) +34 91 060 22 67 (ES) +39 02 87368364 (1T)
Address	Bruchtannenstr. 28, 63801 Kleinostheim, Germany
Website	<a href="http://www.eft-systems.de">www.eft-systems.de</a>
<b>Australia Alps Power Pty Ltd</b>	
Email	<a href="mailto:service@alpspower.com.au">service@alpspower.com.au</a>
Telephone	+61 2 8005 6688
Address	2/62 Belmore Road, Riverwood, NSW 2210
Website	<a href="http://www.alpspower.com.au">www.alpspower.com.au</a>
<b>South Africa Afriplus Energy Group (Pty) Ltd</b>	
Email	<a href="mailto:support@afriplusenergy.co.za">support@afriplusenergy.co.za</a>
Telephone	+27 21 140 3594
Address	The Pavilion, Corner Of Dock & Portswood Road, V&A Waterfront, 8001, Cape Town
Website	<a href="http://www.afriplusenergy.co.za">www.afriplusenergy.co.za</a>
<b>USA BYD US Service</b>	
Email	<a href="mailto:us.homeenergy@byd.com">us.homeenergy@byd.com</a>
Telephone	626-491-2333
Address	888 E Walnut St, Suite 200A, Pasadena, CA 91101, USA

## Appendix 1 Connection Options with Inverters

Before the installation, please first check if the planned configuration is already released according to the latest Battery-Max Lite Compatible Inverter List.

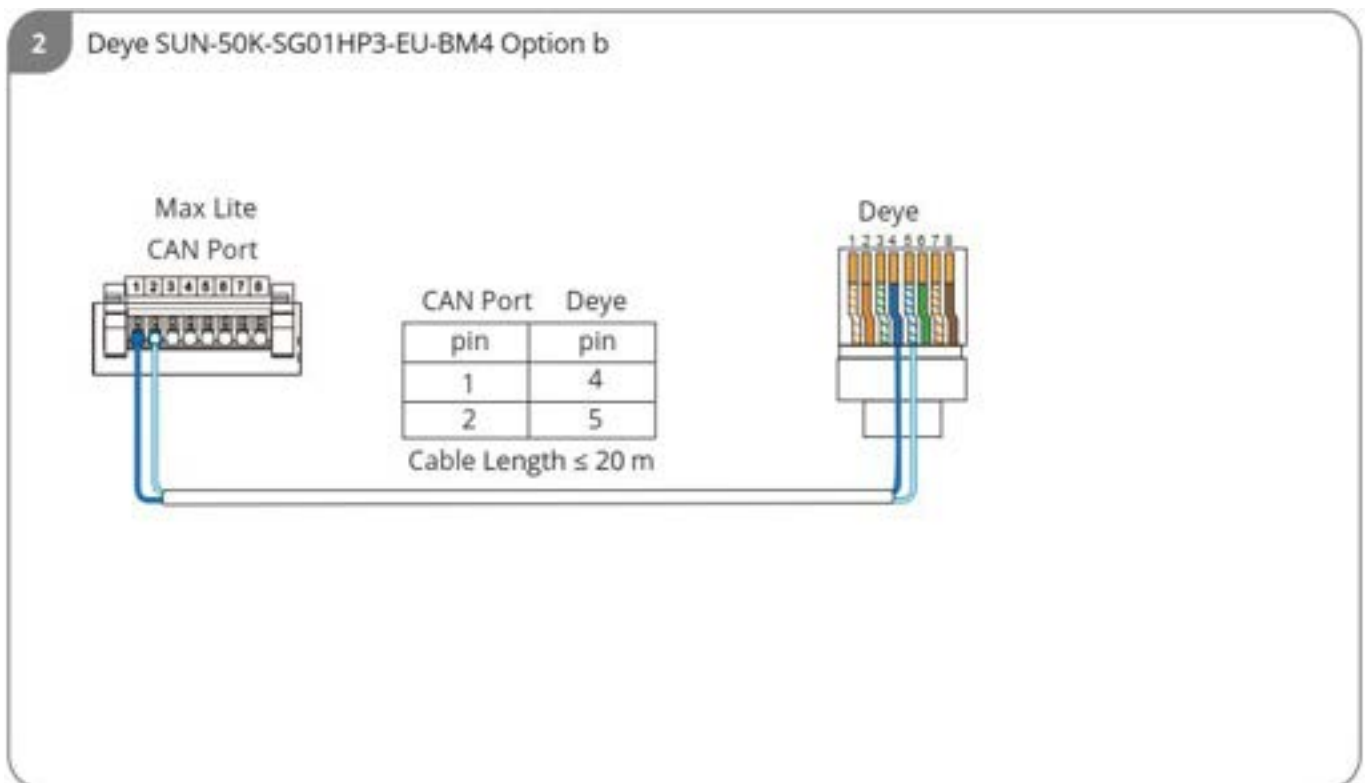
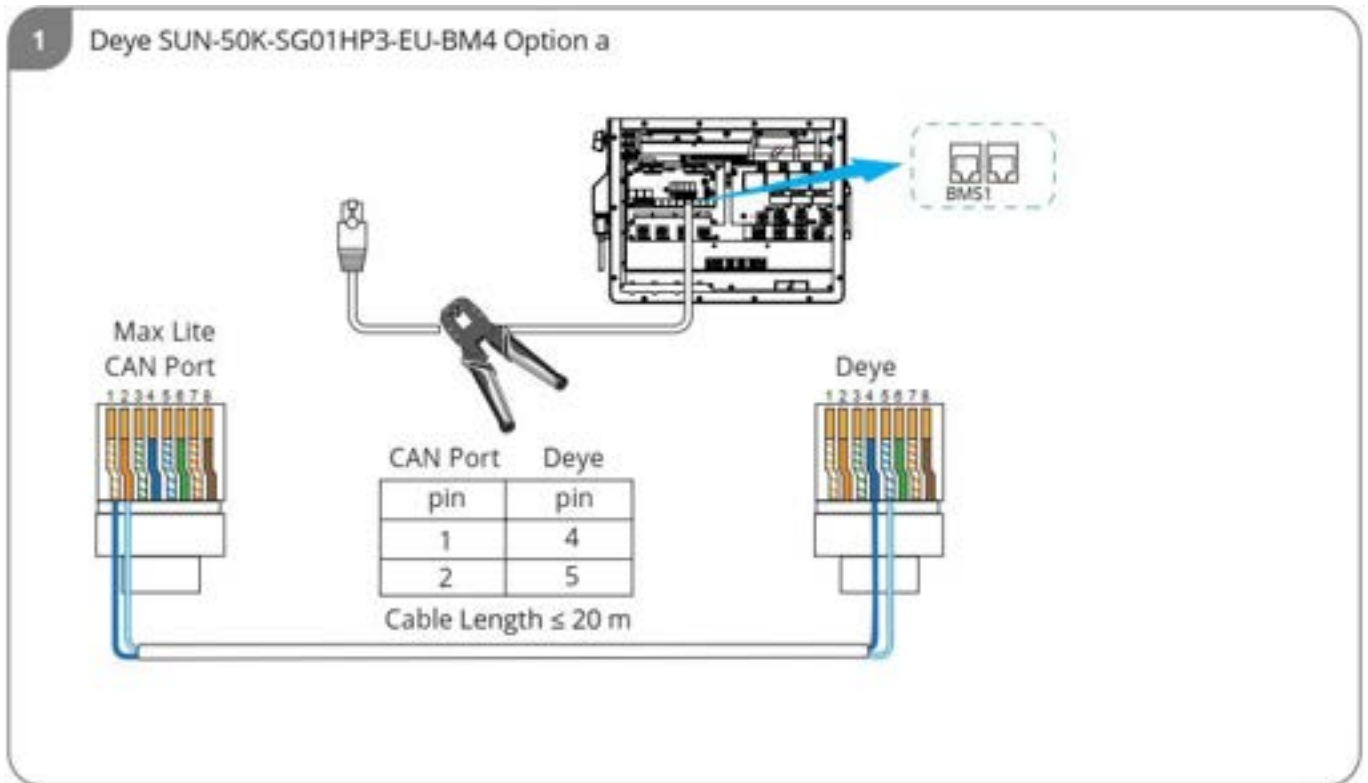

3

Solis S6-EH3P-50K-H Option a

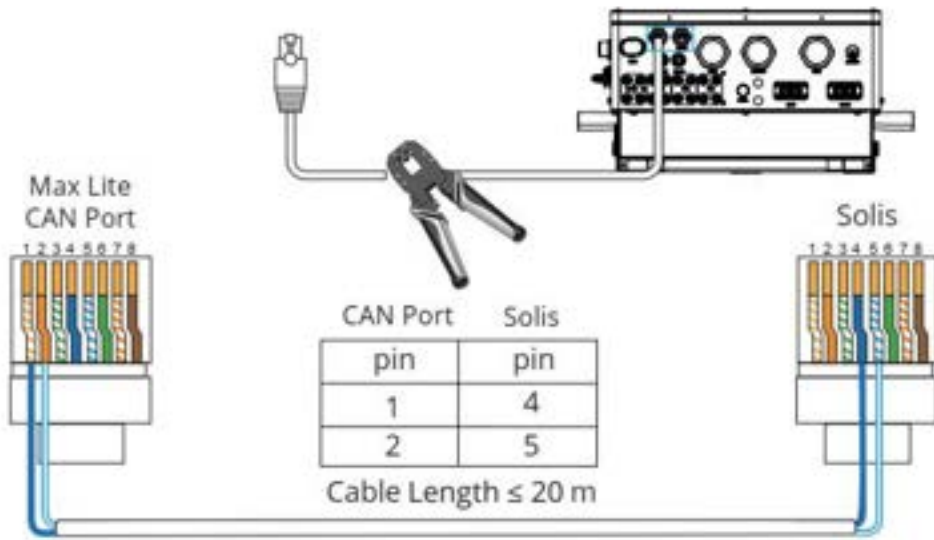

4

Solis S6-EH3P-50K-H Option b

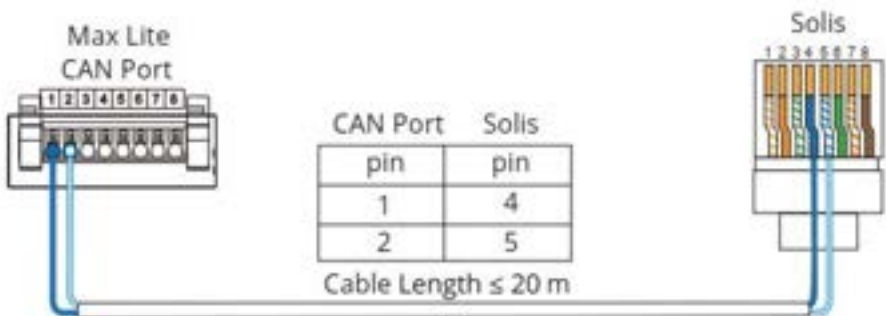

5 SMA Sunny Tripower Storage X 50

Max Lite  
ETH Port



SMA

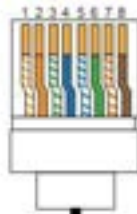

Cable Length  $\leq$  20 m

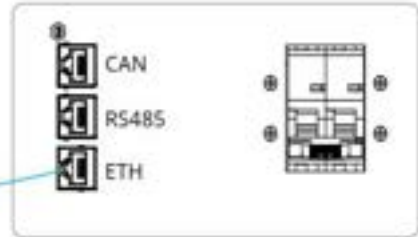

6 Kaco blueplanet gridsave 92.0 TL3-S

Max Lite PDU

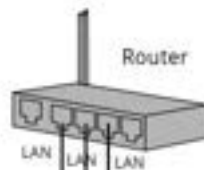
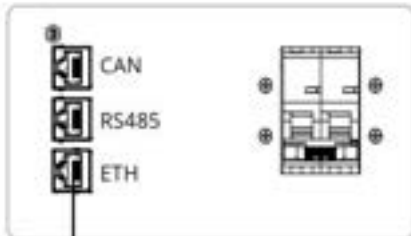

Kaco Inverter



Smart 1 EMS

## Appendix 2 Checklist

Please fill all available information in below table. If there are multiple cabinets in parallel, please print multiple copies of this page separately.

### Installer / Delivery Address / Contact:

Company		ZIP / City	
Contact Person		Phone	
Street / No.		Email	

### The voltage of all the battery modules in a cabinet before installation

Battery Module	Serial Number	Voltage/V	Battery Module	Serial Number	Voltage/V
#1			#7		
#2			#8		
#3			#9		
#4			#10		
#5			#11		
#6			#12		

### System Information:

Battery Configuration (e.g., LITE 90)		PDU Serial Number	
PDU Firmware		PDU Connected to Internet	Yes <input type="radio"/> No <input type="radio"/>
Inverter Brand + Model		Inverter Serial Number	
Inverter Firmware		System Name on Inverter Portal	
Commissioning Date			





17359077-00